

Intelligent LED Driver(Constant Current)

- Housing made of Covestro/Samsung PC flame-retardant V0 raw material, ultra-thin and lightweight, tool-free screwless end cover for easy installation and removal.
- Matter certified device, communicates over IPv6 Thread network and requires a Matter hub with Thread Border Router functionality (such as Apple HomePod mini or Google Nest Hub).
- Supports control via mainstream Matter smart home platforms including Apple Home, Google Home, etc., with voice control support.
- Easy pairing and commissioning via QR code scanning.
- Supports standard Matter OTA updates.
- Supports NFC programming to adjust parameters including output current, dimming fade time, power-on fade time, brightness range, etc.
- T-PWM ultra-deep dimming technology with dimming depth down to 0.0001%.
- 0-100% full-range dimming with no visible flicker, compliant with high-frequency exemption level.
- Built-in soft start and gradual brightening for more comfortable visual experience.
- EU ERP compliant: no-load power consumption and network standby power consumption < 0.5W.
- No-load protection to prevent LED damage from poor contact.
- Over-temperature, overload and short-circuit protection with automatic recovery.
- Suitable for indoor Class I, II and III lighting applications.
- Service life up to 100,000 hours under normal operation.
- 5-year warranty (equipped with Ruby capacitors).



DIM

T-PWM
Dimming Technology

Flicker Free
IEEE 1789

Dimmable:
1:1000000



The certification icon represents undergoing certification applications only, and final certification qualification subject to actual product.

Technical Specs

Model	SE-20-100-700-W1MA			
FEATURES	Output Type	Constant current		
	Dimming Interface	Matter over Thread, Matter 1.4		
	Output Feature	Isolation		
	IP Rating	IP20		
	Insulation Class	Class II (Suitable for class I/II/III light fixtures)		
OUTPUT	Output Voltage	9-42V $\overline{=}$		
	Max. Output Voltage	$\leq 48V \overline{=}$		
	Rated Current Range	100-700mA(Set higher current via mobile APP NFC; step value down to 1mA; Default: 100mA)		
	Load Power Range	0.9W-20W		
	Dimming Range	0-100%, Dimming depth: 0.0001% (Set additional gear ratios via the mobile app's NFC feature,Default:0.01%)		
	LF Current Ripple	<3%(Maximum current for non dimming state)		
	Current Accuracy	$\pm 5\%$		
INPUT	PWM Frequency	$\leq 3600Hz$		
	DC Voltage Range	100-240V $\overline{=}$		
	AC Voltage Range	100-240V~		
	DC Current Range	0.09-0.25A		
	Rated Voltage	115V~ /230V~		
	Frequency	0/50/60Hz		
	Input Current	$\leq 0.25A/115V\sim, \leq 0.13A/230V\sim$		
	Power Factor	PF>0.95/115V~ (Fully loaded), PF>0.9C/230V~ (Fully loaded)		
	THD	THD $\leq 10\%/230V\sim$ (Fully loaded)		
	Efficiency(Typ.)	84%@700mA (Fully loaded) ,87%@500mA (Fully loaded)		
ENVIRONMENT	Inrush Current	Cold start 15A(Test twidth=102us tested under 50% Ipeak)/230V~		
	Anti Surge	L-N: 2KV		
	Leakage Current	Max. 0.24mA		
	Operating Temperature	ta: -20 ~ 50°C tc: 80°C		
	Working Humidity	20 ~ 95%RH, non-condensing		
PROTECTION	Storage Temperature/Humidity	-40 ~ 80°C/10~95%RH		
	Temperature Coefficient	$\pm 0.03\%/^{\circ}C(-20-45^{\circ}C)$		
	Vibration	10-500Hz, 2G 12min/1cycle, 72 min for X, Y and Z axes respectively		
	Overload Protection	Automatically protect the device when the load exceeds 102% of the rated power. Automatically recover once load is reduced		
	Overheat Protection	Intelligently adjust or turn off the current output if the PCB temperature $\geq 110^{\circ}C$. When the PCB temperature <90°C, automatically recover normal output		
SAFETY & EMC	Overvoltage Protection	Automatically protect the device when voltage exceeds the no-load voltage. It can be recovered automatically		
	Short Circuit Protection	Enter hiccup mode if short circuit occurs, and recover automatically		
	Withstand Voltage	I/P-O/P: 3750V~		
	Insulation Resistance	I/P-O/P: 100M Ω /500VDC/25°C/70%RH		
	Safety Certifications	CCC	China	GB19510.1, GB19510.14, GB19510.213
		CB	CB Member States	IEC61347-1, IEC61347-2-13
		CE	European Union	EN61347-1, EN61347-2-13, EN62384
		CUL	Canada	CSA C22.2 No.250.13
		UL	United States	UL 8750
	EMC Emission	CCC	China	GB/T17743, GB17625.1
CE		European Union	EN55015, EN61000-3-2, EN61000-3-3, EN61547	
CUL		Canada	ICES-005	
UL		United States	FCC part 15B	
ErP		EMC Immunity	EN61000-4-2,3,4,5,6,8,11, EN61547	
	Power Consumption	Networked standby	< 0.5W(After shutdown by command)	
		No-load power consumption	< 0.5W (When the lamp is not connected)	
	Flicker/Stroboscopic Effect	IEEE 1789	Meet IEEE 1789 standard/High frequency exemption level	
		CIE SVM	Pst LM ≤ 1.0 , SVM ≤ 0.4	
DF	Phase factor	DF ≥ 0.9		
OTHERS	Weight(N.W.)	110g $\pm 10g$		
	Dimensions	127*40*23mm(L*W*H)		

Typical Current Corresponding Parameter Table

The following 13 groups of typical current data are provided for model selection reference. More currents can be set via the mobile phone APP NFC.
The settable range is 100-700mA, and the current step value can be as low as 1mA.

Output Current	100mA	150mA	200mA	250mA	300mA	350mA	400mA
Output Voltage	9-42Vdc	9-42Vdc	9-42Vdc	9-42Vdc	9-42Vdc	9-42Vdc	9-42Vdc
Output Power	0.9-4.2W	1.35-6.3W	1.8-8.4W	2.25-10.5W	2.7-12.6W	3.15-14.7W	3.6-16.8W

Output Current	450mA	500mA	550mA	600mA	650mA	700mA	/
Output Voltage	9-42Vdc	9-40Vdc	9-37Vdc	9-34Vdc	9-31Vdc	9-28.5Vdc	/
Output Power	4.05-18.9W	4.5-20W	4.95-20.35W	5.4-20.4W	5.85-20.15W	6.3-19.95W	/

Product Size

Unit: mm

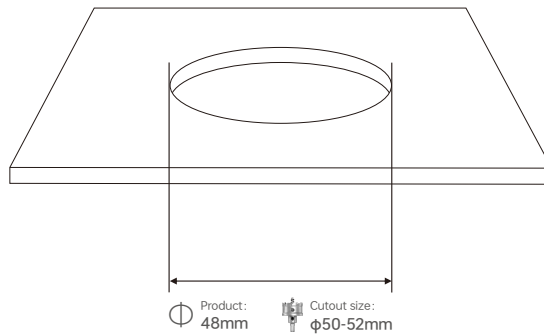
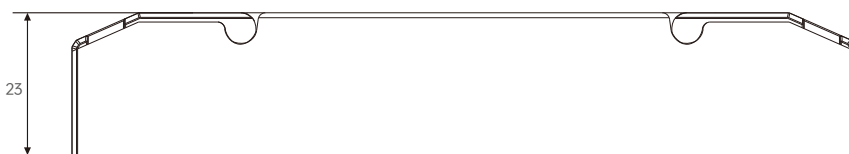
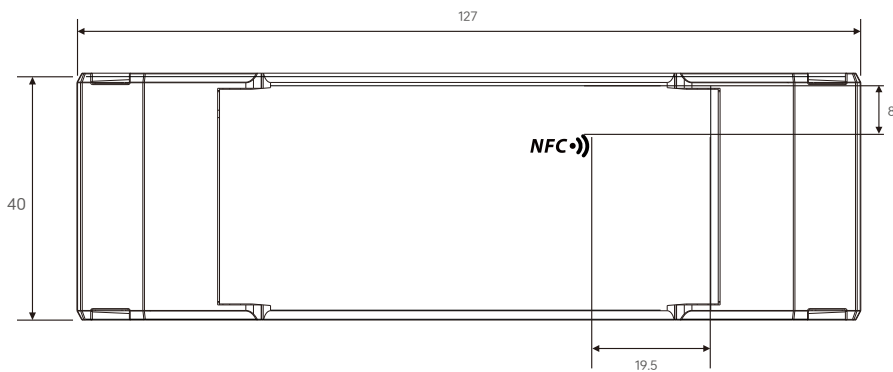

Connectivity Diagram

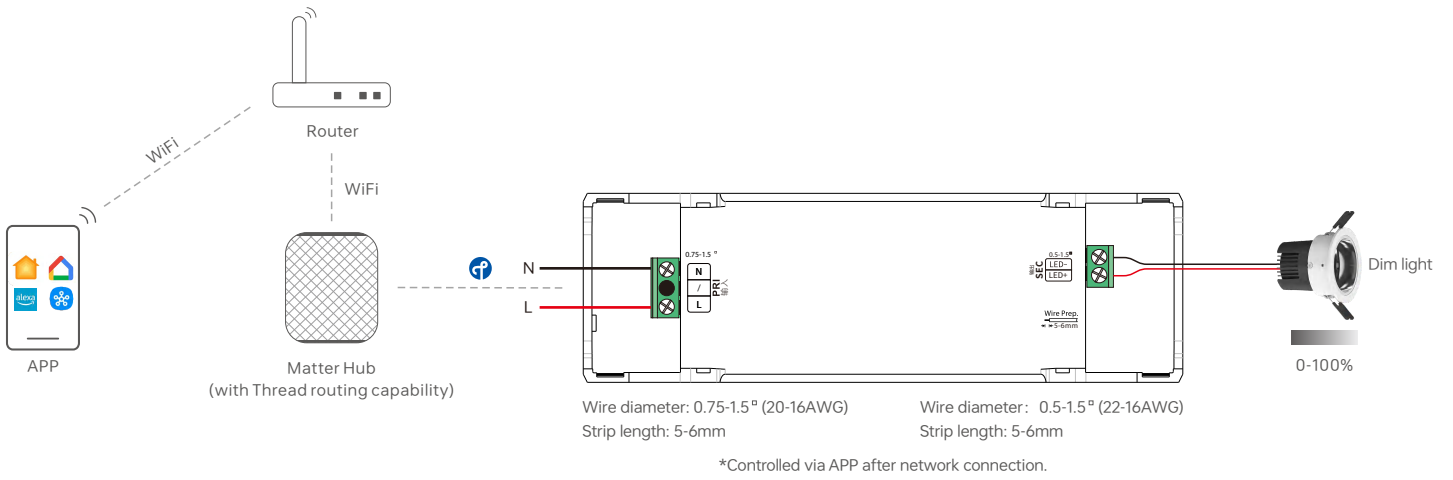

Application Diagram of Protective Cover

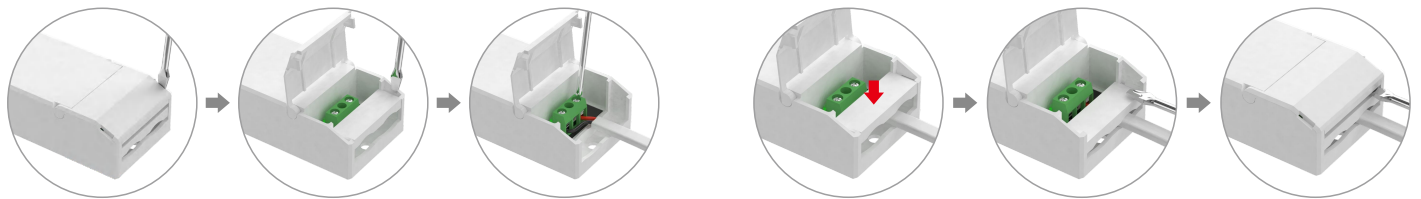

1. Put the head of a screwdriver on the side of the housing to pry up both the protective cover and wire fixing board. Then remove the wire fixing board and connect to the wires as wiring diagram shows.

2. Install the wire fixing board and press it down. Then snap on the protective cover while pressing the wire fixing board with a small flat-head screwdriver

Installation Precautions

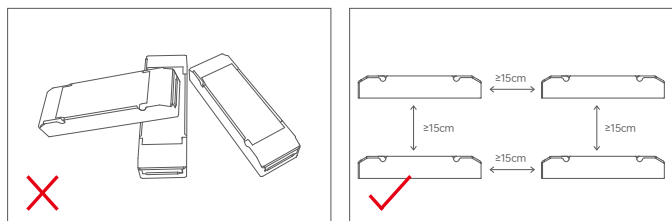

Please do not stack the products. The distance between two products should be $\geq 15\text{cm}$ so as not to affect heat dissipation and the lifespan of the products.

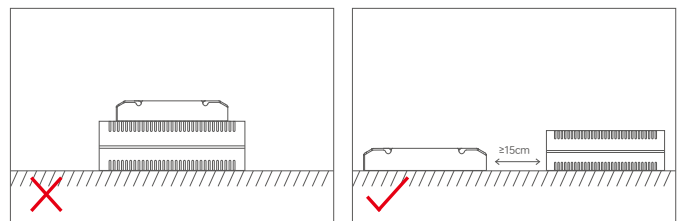

Please do not place the products on the floor. The distance between the product and the floor should be $\geq 100\text{cm}$ so as to avoid signal interference.

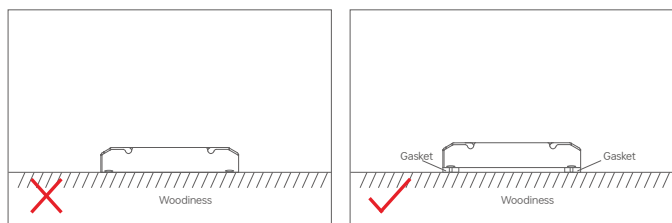

Do not fix the product tightly against the wooden board with screws. Please add a washer $\geq 7\text{mm}$ thick under the mounting screws to leave a gap for effective heat dissipation, so as to avoid affecting the heat dissipation and service life of the product.

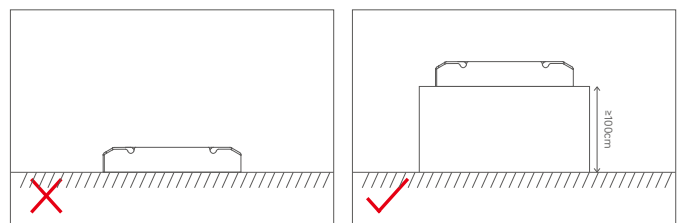

Please do not place the products on the floor. The distance between the product and the floor should be $\geq 100\text{cm}$ so as to avoid signal interference.

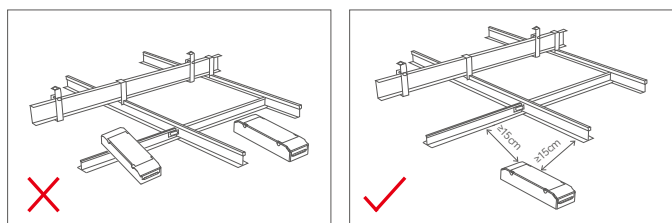

Do not allow the product to come into large-area contact with metal objects (e.g. keel frames). The separation distance shall be $\geq 15\text{cm}$ to avoid signal interference affecting operation.

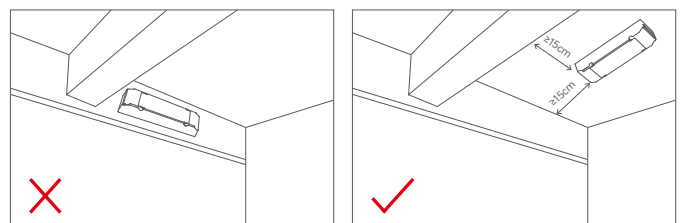

Please do not install the products on beams or near the corners. The distance between the product and the beam or the corner should be $\geq 15\text{cm}$ so as to avoid signal interference.

Relationship Diagrams

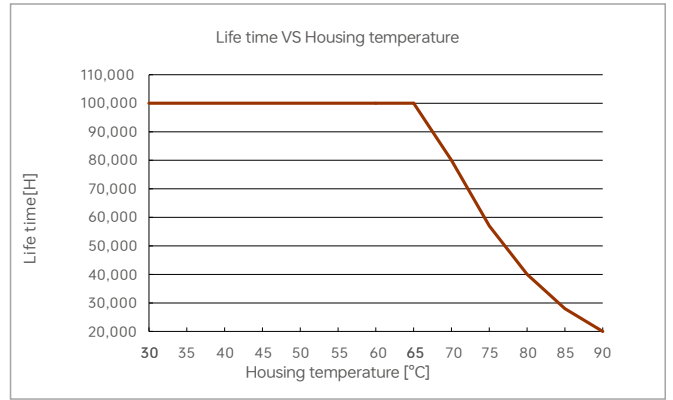
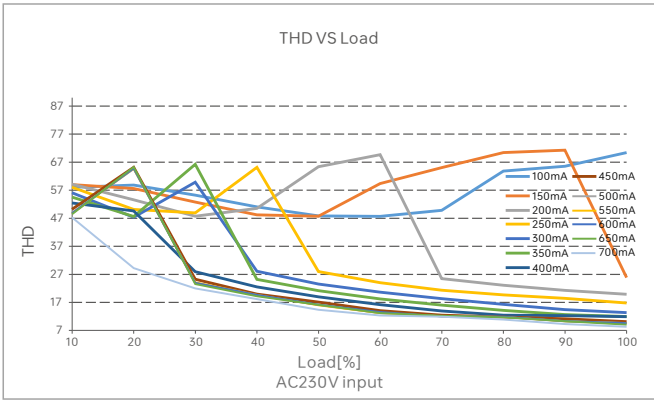
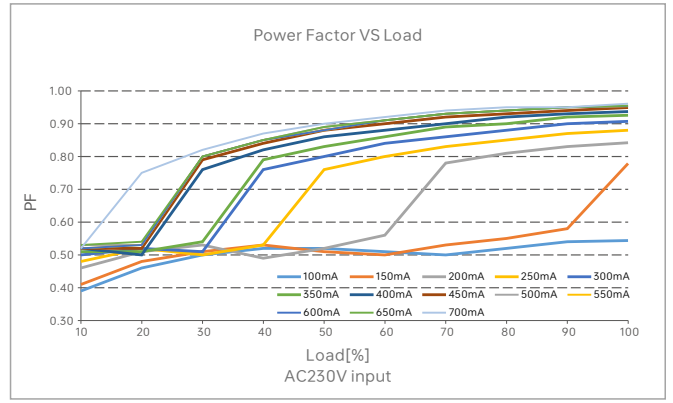
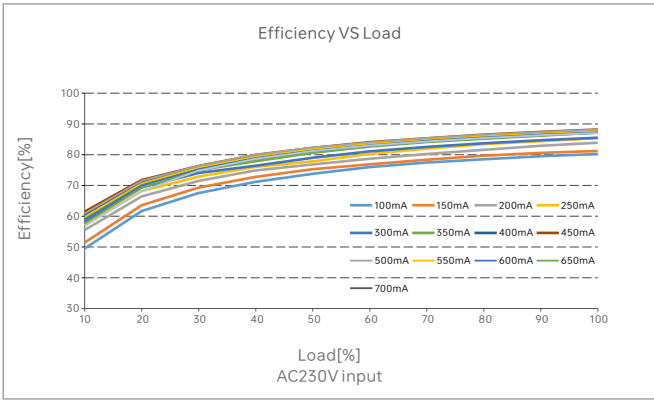

SE-20-100-700-W1MA

Flicker Test Sheet

IEEE 1789

Limit of modulation in low risk area	
Waveform frequency of optical output	limit (%)
$f \leq 8\text{Hz}$	0.2
$8\text{Hz} < f \leq 90\text{Hz}$	$0.025 \times f$
$90\text{Hz} < f \leq 1250\text{Hz}$	$0.08 \times f$
$f > 1250\text{Hz}$	Exemption assessment
Limit of modulation in no effect area	
Waveform frequency of optical output	limit (%)
$f \leq 10\text{Hz}$	0.1
$10\text{Hz} < f \leq 90\text{Hz}$	$0.01 \times f$
$90\text{Hz} < f \leq 3125\text{Hz}$	$(0.08/2.5) \times f$
$f > 3125\text{Hz}$	Exemption assessment (High frequency exemption)

Brightness

- ▲ 0.1%
- ◆ 1%
- ▲ 5%
- ◆ 10%
- 20%
- ▲ 30%
- 40%
- ★ 50%
- 60%
- 70%
- ◆ 80%
- ★ 90%
- ◆ 100%

Modulation Area Diagram

High Frequency Exemption Area Diagram

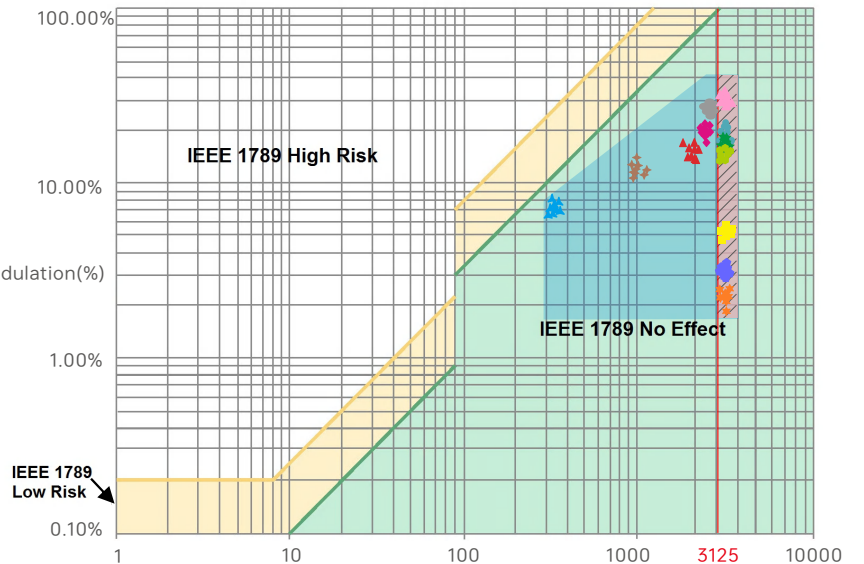

Marks in the right chart were tested results of different current ranges. The output frequency is 0Hz in 100% brightness and its corresponding modulation is 0%, which could not be shown in the right chart.

Add to Matter Platform Instructions

1. This device supports control via major smart home platforms, including Apple Home, Amazon Alexa, Google Home, SmartThings, and others.
2. To connect Matter over Thread devices, you need a Matter hub supporting Thread border router functionality from major platforms. Refer to the image below for compatible models.

 Apple Home	 SmartThings	 Google Home	 Amazon Alexa
Apple HomePod (second-gen)	Aeotec SmartThings Smart Home Hub	Google Nest Hub (2nd Gen)	Amazon Echo (4th-gen)
Apple HomePod Mini	Samsung SmartThings Station	Google Nest Hub Max	Amazon Echo Hub
Apple TV 4K (2nd gen)	Samsung SmartThings Hub Dongle	Google Nest Wifi Pro	Amazon Echo Show 8 (3rd-gen)
Apple TV 4K (3rd gen, 128 GB)	Samsung SmartThings Hub v3	Google TV Streamer (4K)	Amazon Eero 6, Pro 6, 6 Plus, Max 7 etc.

3. This guide uses Apple Home as an example. First, prepare an iPhone (iOS 16.2 or later) or iPad (iPadOS 16.2 or later) with the latest firmware, along with an Apple HomePod mini also running the latest firmware. Then connect your iPhone or iPad to your home Wi-Fi network, launch the Apple Home app, and follow Apple's instructions to set up the HomePod mini.

*For iPhone models 16 and above, no Matter hub is required; devices can be added directly.

Adding Steps (Using Apple Home as an Example)

1. Add Accessory

Open the Apple Home app, tap Add or Scan Accessory, and add the device to the Home app by scanning the QR code label on the device, as shown below.

*Alternatively, add via NFC: Open the Home app, bring it close to the device's NFC sensing area for recognition and network connection.

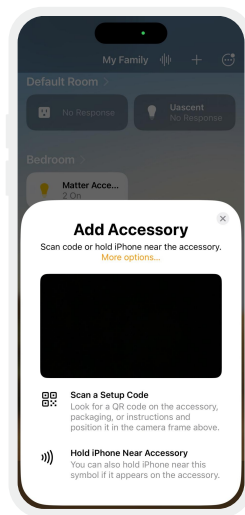
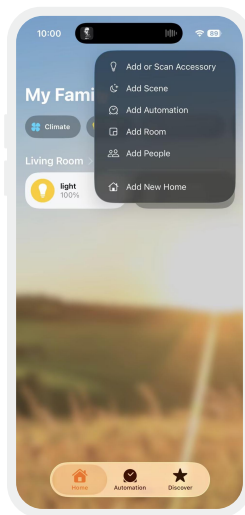

2. Control the Device

After the device has been successfully added, tap the device icon to turn it ON/OFF; tap the device card to enter the brightness control interface.

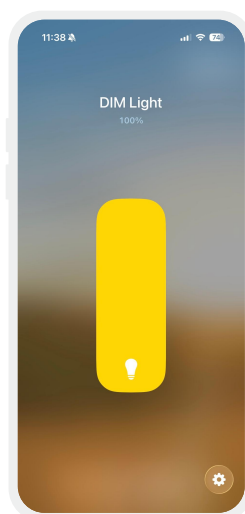
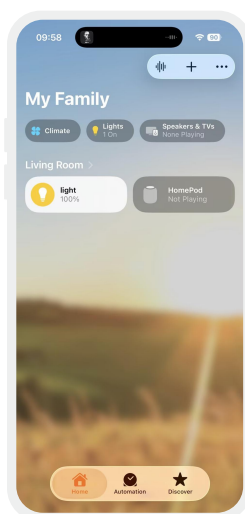

3. Advanced Functions

Supports creating groups, scenes, automation, remote control and timer control. The device can also be controlled via Siri voice commands.

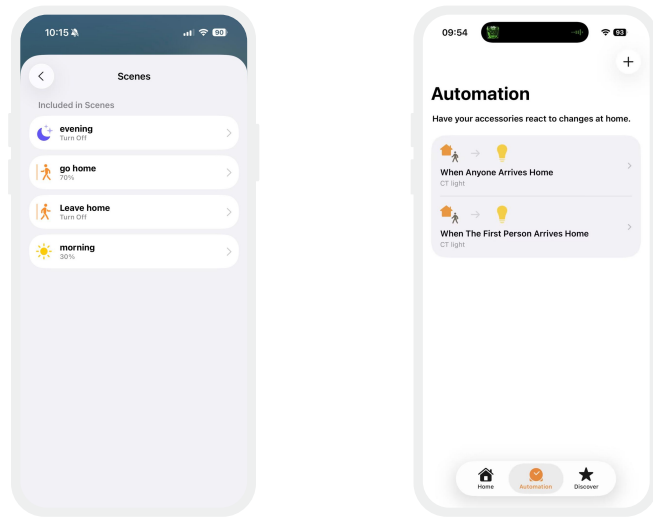

4. Multi-Ecosystem Network Configuration

If the product needs to be added to two or more ecosystems, you may go to the device settings page, tap Enable Pairing Mode, obtain the pairing code, and add it to third-party platforms.

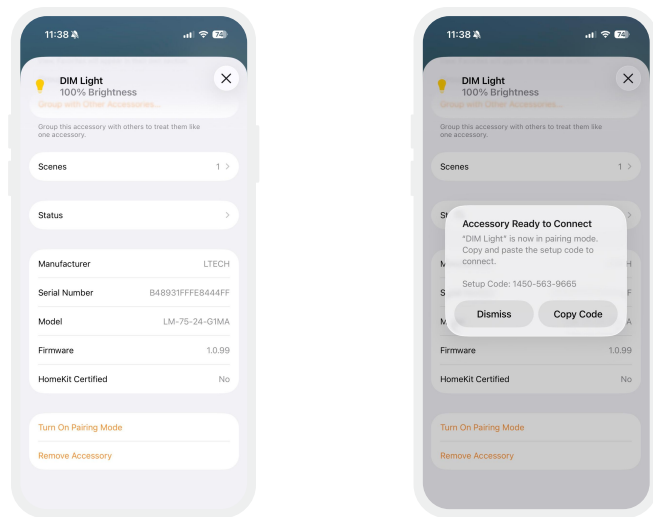

Reset to the defaults

Ensure the device is connected to the light and the light stays on steadily. Turn the power off and on 6 times in a row using the switch: (Turn off for 15 seconds, Turn on for 2 seconds) After the 6th time you turn it on (leave it on for 2 seconds), the light will flash 5 times. This means the device has been successfully restored to factory settings.

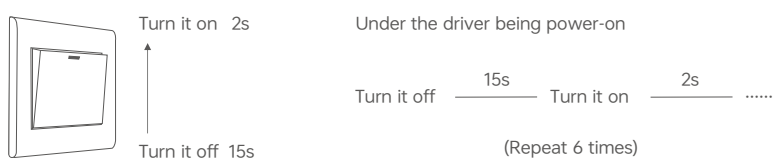

Use the NFC Lighting APP

Scan the QR code below with your mobile phone and follow the prompts to complete the APP installation (According to performance requirements, you need to use a NFC-capable Android phone, or an iPhone 8 and later that are compatible with iOS 13 or higher).



* Before you begin setting the parameters of the driver, please make sure the driver is powered off .

Read/Write the LED driver

Use your NFC-capable phone to read LED driver data, then edit the parameters and they can be directly written to the driver.

1.Read the LED driver

On the APP home page, click **【Read/Write LED driver】** , then keep the programmer's sensing area close to the NFC sensing area of the driver to read the driver parameters.

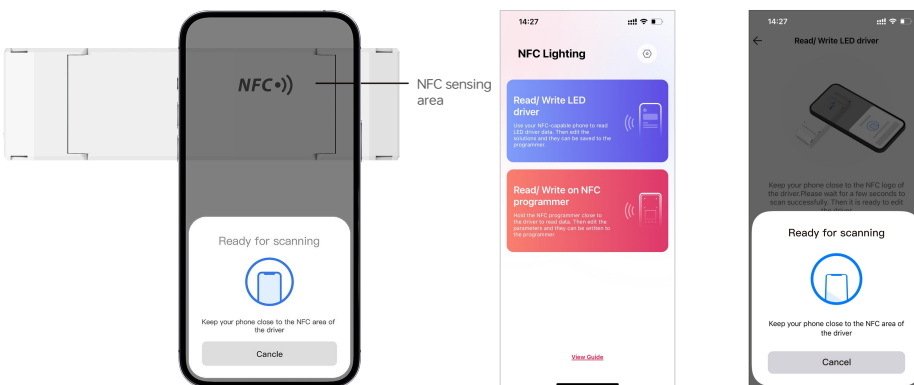

2.Edit the parameters

Click **【Parameter settings】** to edit more advanced parameters such as output current, dimming fade time, power-on fade time, Dimming Depth, brightness range, power-on state.

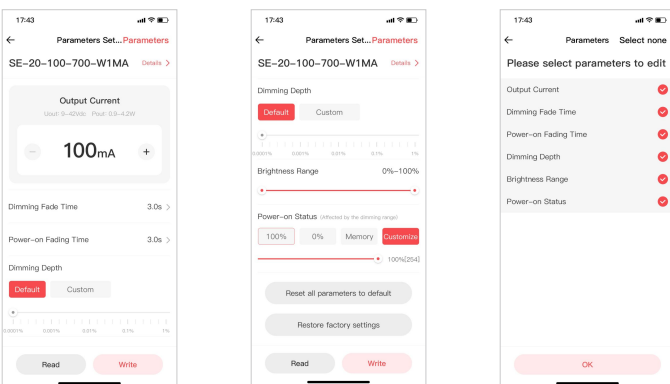

3.Write to the driver

After completing the parameter settings, click **【Write】** in the upper right corner, and keep the programmer's sensing area close to the NFC sensing area of the driver, so the parameters can be written to the driver.

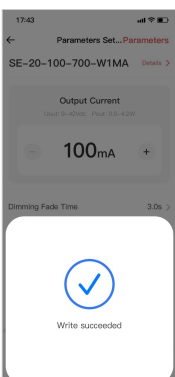

Packaging Specifications

Model	SE-20-100-700-W1MA
Carton Dimensions	372×355×105mm(L×W×H)
Quantity	32 PCS/Layer; 2 Layers/Carton; 64 PCS/Carton
Weight	0.115kg/PC; 7.4 kg±5%/Carton

Packaging Image

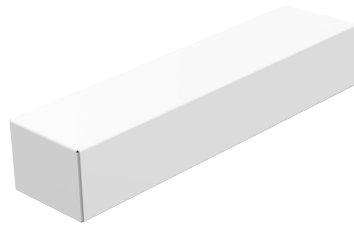

Inner Packaging Box



Carton Packaging

FAQ

This product is designed in compliance with the Matter protocol standard. As the protocol is still in the early stage of industry development and limited by the current version, some functions, performance and network connection stability may be subject to further optimization. Product performance is subject to the current version of the Matter protocol. Our company will continuously upgrade and optimize product functions and performance in line with official updates. Please kindly note.

1. What should I do if the large number of Matter devices managed by the Matter hub gateway causes unstable connections and control?

1.1 It is recommended that each hub gateway add no more than 40 Matter devices.

1.2 It is recommended that the hub gateway remain powered on at all times; otherwise, the device reconnection time will be long.

1.3 Routers of different brands and performances have a certain impact on the number of devices managed by the Matter hub. It is recommended to choose a high-performance router.

2. What should I do if packet loss occurs during group control switching or dimming, and the app status flips back and forth?

It is recommended to keep the number of devices in a group within 10 units.

3. What should I do if the device goes offline and cannot recover after a long period of inactivity?

It is recommended to power the device off and on again to reconnect.

4. What should I do if adding the device still fails after restoring it to factory settings?

Please try powering the device off and on again before adding it.

5. Common reasons for failed device addition caused by router issues.

5.1 The router must have the IPv6 option enabled.

5.2 The router must have the "Brute-force network attack prevention" option disabled.

5.3 Do not connect to the guest Wi-Fi; connect to the main Wi-Fi network instead.

Transportation and Storage

1. Transportation

Products can be shipped via vehicles, boats and planes.

During transportation, products should be protected from rain and sun. Please avoid severe shock and vibration during the loading and unloading process.

2. Storage

The storage conditions should comply with the Class I Environmental Standards. The products that have been stored for more than six months are recommended to be re-inspected and can be used only after they have been qualified.

Attentions

- Products shall be installed by qualified professionals.
- LTECH products are and not lightningproof non-waterproof (special models excepted). Please avoid the sun and rain. When installed outdoors, please ensure they are mounted in a water proof enclosure or in an area equipped with lightning protection devices.
- Good heat dissipation will prolong the working life of products. Please ensure good ventilation.
- Please check if the working voltage used complies with the parameter requirements of products.
- The diameter of wire used must be able to load the light fixtures you connect and ensure the firm wiring.
- Before you power on products, please make sure all the wiring is correct in case of incorrect connection that causes damage to light fixtures.
- If a fault occurs, please do not attempt to fix products by yourself. If you have any question, please contact your suppliers.

* This manual is subject to changes without further notice. Product functions depend on the goods. Please feel free to contact our official distributors if you have any question.

Warranty Agreement

- Warranty periods from the date of delivery: 5 years.
- Free repair or replacement services for quality problems are provided within warranty periods.

Warranty exclusions below:

- Beyond warranty periods.
- Any artificial damage caused by high voltage, overload, or improper operations.
- Products with severe physical damage.
- Damage caused by natural disasters and force majeure.
- Warranty labels and barcodes have been damaged.
- No any contract signed by LTECH.

1. Repair or replacement provided is the only remedy for customers. LTECH is not liable for any incidental or consequential damage unless it is within the law.

2. LTECH has the right to amend or adjust the terms of this warranty, and release in written form shall prevail.

LED智能调光驱动器(恒流型)

- 科思创/三星PC阻燃V0级原料外壳，超小轻薄，免螺丝端盖易装拆；
- Matter认证设备，通过IPv6 Thread网络进行通信，需要搭配具备Thread边界路由器功能的Matter中枢使用（如Apple HomePod mini或Google NestHub）；
- 支持主流Matter智能家居平台控制，包括 Apple Home、Google Home等，并支持语音控制；
- 通过扫描二维码轻松配对和调试；
- 支持Matter标准OTA升级；
- 支持NFC编程更改输出电流、调光渐变时间、通电渐变时间、亮度范围等参数；
- T-PWM超深度调光技术，调光深度可达0.0001%；
- 0-100%全程调光无可视频闪，高频豁免考核级别；
- 带软启动渐亮功能，让人眼视觉更舒服；
- 欧盟ERP空载功耗、网络待机功耗 < 0.5W；
- 空载保护，防止接触不良损坏LED灯具；
- 过温、过载、短路保护，可自动恢复；
- 适合室内I、II、III类灯具应用；
- 常规使用下寿命可达10万小时；
- 5年保修期（采用红宝石电容）



T-PWM
超深度调光技术

无频闪
IEEE 1789
高频豁免考核级别

Dimmable: 「**NFC**」
1:1000000



认证图标仅代表产品正在进行一系列的认证申请，认证资质以产品实物为准。



技术参数

型号	SE-20-100-700-W1MA			
特征	输出类型	恒流		
	调光接口	Matter over Thread, Matter 1.4		
	输出特征	隔离		
	防护等级	IP20		
输出	绝缘等级	II类 (适用于室内I、II、III类灯具)		
	输出电压	9-42V _{rms}		
	最大输出电压(空载)	≤48V _{rms}		
	工作电流范围	100-700mA (通过手机APP NFC设置更多电流, 步进值低至1mA; 默认: 100mA)		
	负载功率范围	0.9W-20W		
	调光范围	0-100%, 调光深度: 0.0001%(通过手机APP NFC设置更多档位, 默认: 0.01%)		
	电流纹波	<3%(输出最大电流非调光状态)		
	电流精度	±5%		
输入	PWM频率	≤3600Hz		
	直流电压范围	100-240V _{rms}		
	交流电压范围	100-240V~		
	直流电流范围	0.09-0.25A		
	额定电压	115V~/230V~		
	频率范围	0/50/60Hz		
	输入电流	≤0.25A/115V~, ≤0.13A/230V~		
	功率因数	PF>0.95/115V~ (满载), PF>0.9C/230V~ (满载)		
	谐波THD	THD≤10%/230V~ (满载)		
	效率(Typ.)	84%@700mA(满载), 87%@500mA(满载)		
	浪涌电流	冷启动, 15A (在50%I _{peak} 下测t _{width} =102us)@230V~		
抗浪涌	L-N: 2KV			
漏电流	Max. 0.24mA			
环境	工作温度	ta: -20~50°C tc: 80°C		
	工作湿度	20~95%RH, 无冷凝		
	储存温度/湿度	-40~80°C/10~95%RH		
	温度系数	±0.03%/°C(-20~50°C)		
保护	耐振动	10-500HZ, 2G 12分钟/周期, X, Y, Z轴各72分钟		
	过载保护	负载超过额定功率≥1.02倍时自动保护, 减轻负载自动恢复		
	过温保护	根据PCB温度超标情况(≥110°C), 智能调节电流输出或关闭, 可自动恢复; PCB温度 < 90°C时, 可自动恢复正常输出		
	过压保护	超过空载电压值进入保护, 可自行恢复		
	短路保护	输出线路短路进入打嗝模式, 可自动恢复		
安规和电磁规格	耐压	输入对输出: 3750V~		
	绝缘阻抗	输入对输出: 100MΩ/500VDC/25°C/70%RH		
	安全规范	CCC	中国	GB19510.1, GB19510.14, GB19510.213
		CB	CB成员国	IEC61347-1, IEC61347-2-13
		CE	欧盟	EN61347-1, EN61347-2-13, EN62384
		CUL	加拿大	CSA C22.2 No.250.13
		UL	美国	UL 8750
	电磁兼容发射	CCC	中国	GB/T17743, GB17625.1
		CE	欧盟	EN55015, EN61000-3-2, EN61000-3-3, EN61547
		CUL	加拿大	ICES-005
UL		美国	FCC part 15B	
电磁兼容抗扰度	EN61000-4-2,3,4,5,6,8,11, EN61547			
ErP	功耗	网络待机功耗	< 0.5W (通过指令开关后)	
		空载功耗	< 0.5W (不接灯具时)	
	频闪/频闪效应	IEEE 1789	满足无影响/高频豁免考核级别	
		CIE SVM	Pst LM≤1.0, SVM≤0.4	
其他	DF	相位因素	DF≥0.9	
	产品重量	110g±10g		
	产品尺寸	127×40×23mm(L×W×H)		

典型电流对应参数表

下图典型13组电流数据供选型参考，均可通过手机APP NFC设置更多电流，可设置范围在100-700mA，电流步进值低至1mA

输出电流	100mA	150mA	200mA	250mA	300mA	350mA	400mA
输出电压	9-42Vdc	9-42Vdc	9-42Vdc	9-42Vdc	9-42Vdc	9-42Vdc	9-42Vdc
输出功率	0.9-4.2W	1.35-6.3W	1.8-8.4W	2.25-10.5W	2.7-12.6W	3.15-14.7W	3.6-16.8W
输出电流	450mA	500mA	550mA	600mA	650mA	700mA	/
输出电压	9-42Vdc	9-40Vdc	9-37Vdc	9-34Vdc	9-31Vdc	9-28.5Vdc	/
输出功率	4.05-18.9W	4.5-20W	4.95-20.35W	5.4-20.4W	5.85-20.15W	6.3-19.95W	/

尺寸图

单位：mm

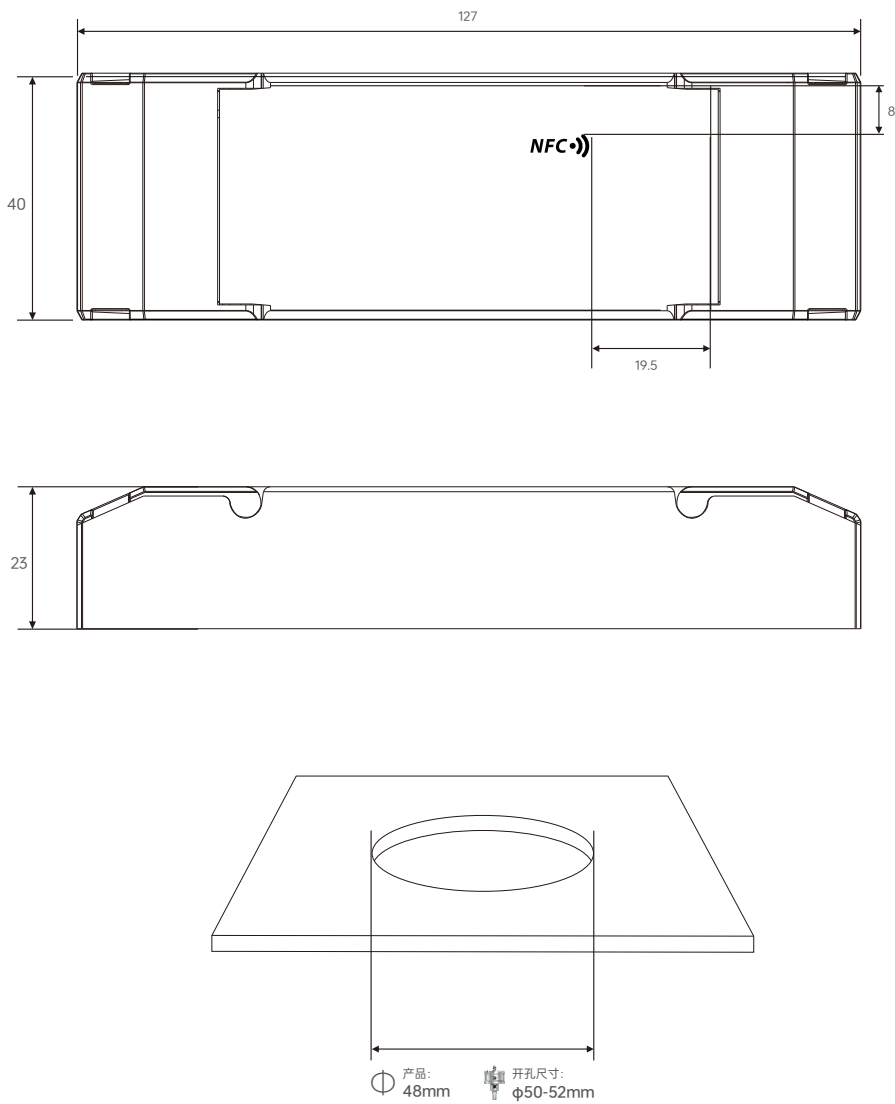

连接应用图

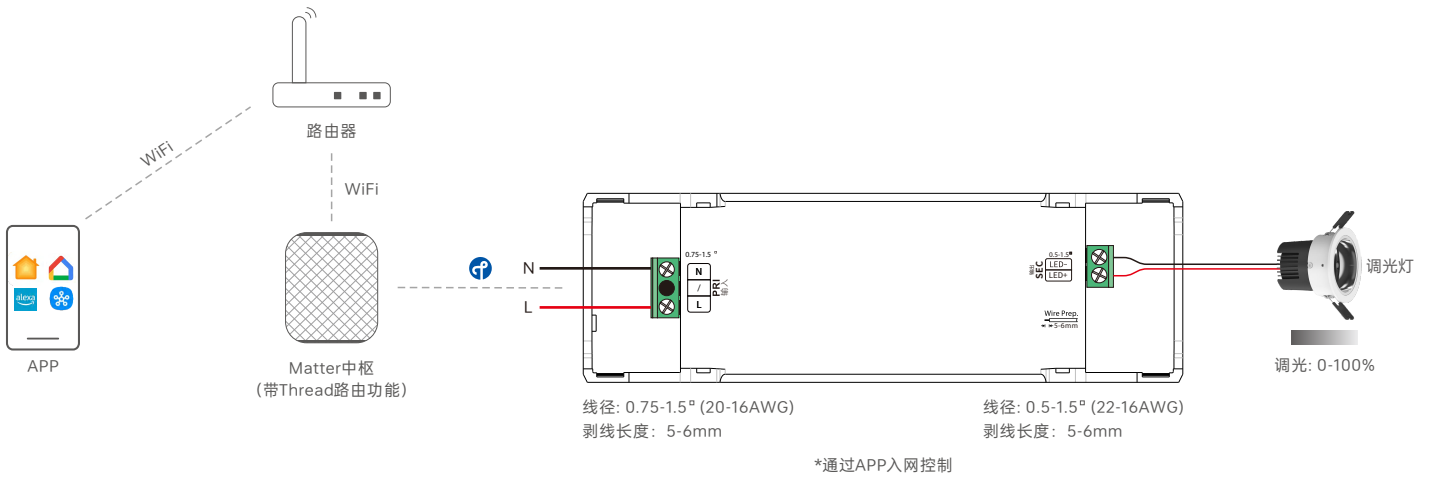

保护盖应用图



1. 在侧板处使用螺丝批撬起保护盖，并撬起压线板将其拆下后，按照接线图进行接线。

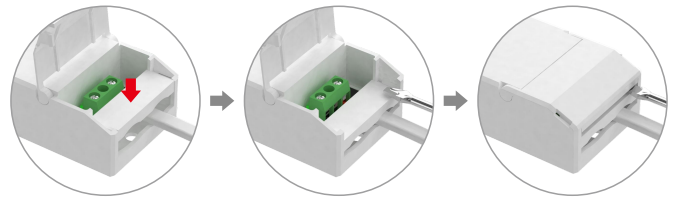

2. 装上压线板并向下按压，使用小一字螺丝批按压住压线板的同时，将保护盖向下扣合即可。

安装注意事项

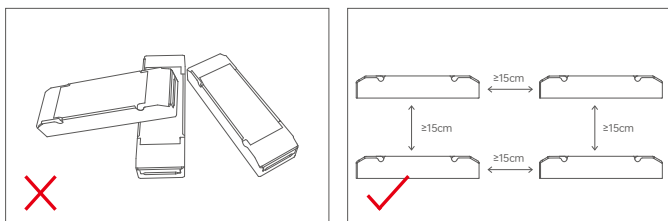

请勿将产品堆叠摆放，产品与产品间隔距离应 $\geq 15\text{cm}$ ，避免影响产品散热和使用寿命。

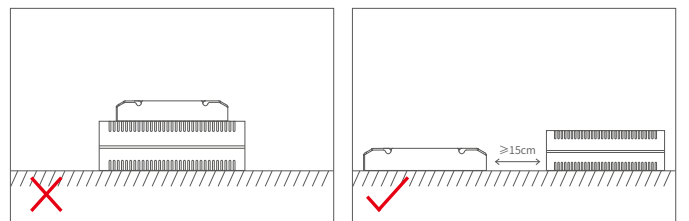

请勿将产品置于电源上方，产品与电源间隔距离应 $\geq 15\text{cm}$ ，避免影响产品散热而减少使用寿命。

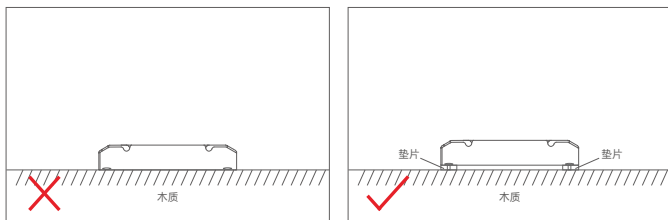

请勿将产品螺丝固定紧贴于木板，应在固定螺丝下增加 $\geq 7\text{mm}$ 的垫片，留点空隙可以有效散热，避免影响产品散热和使用寿命。

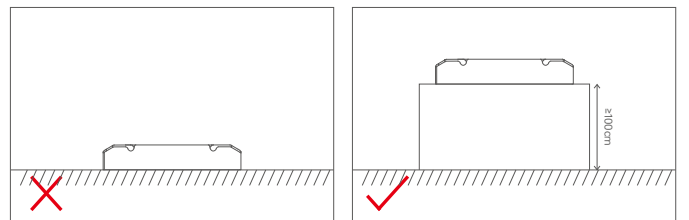

请勿将产品放置在地面上。产品与地面之间的距离应 $\geq 100\text{cm}$ ，以免信号干扰影响使用。

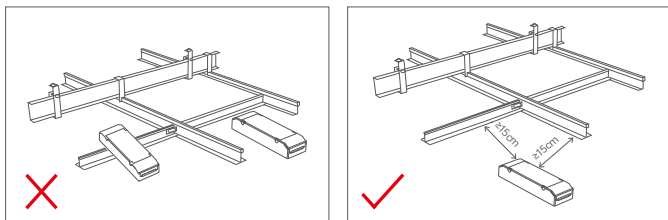

请勿将产品大面积接触金属物体(如: 龙骨架)，间隔距离应 $\geq 15\text{cm}$ ，以免信号干扰影响使用。

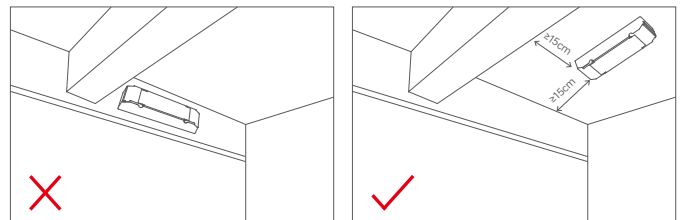

请勿将产品安装在横梁、墙角等位置，间隔距离应 $\geq 15\text{cm}$ ，以免信号干扰影响使用。

关系图表

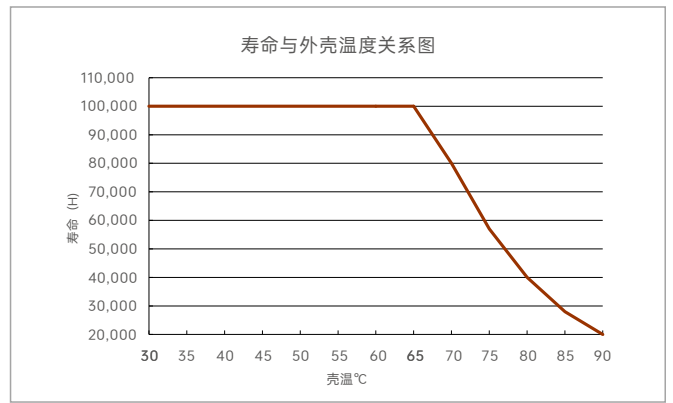
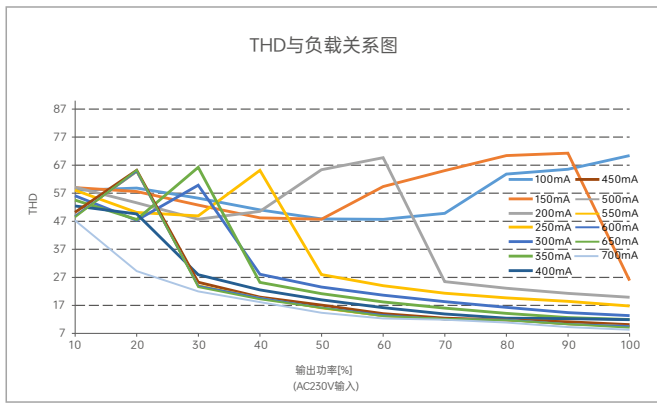
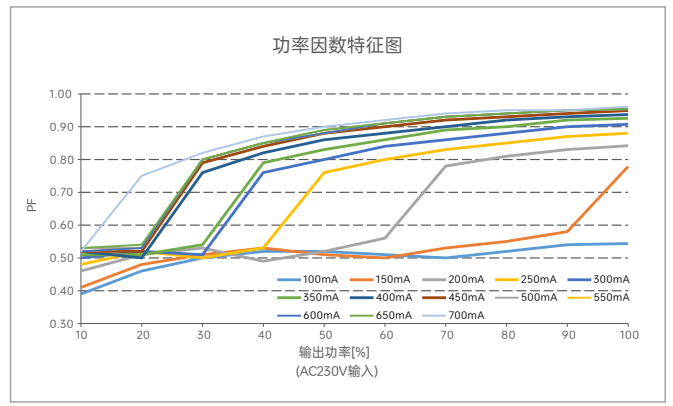
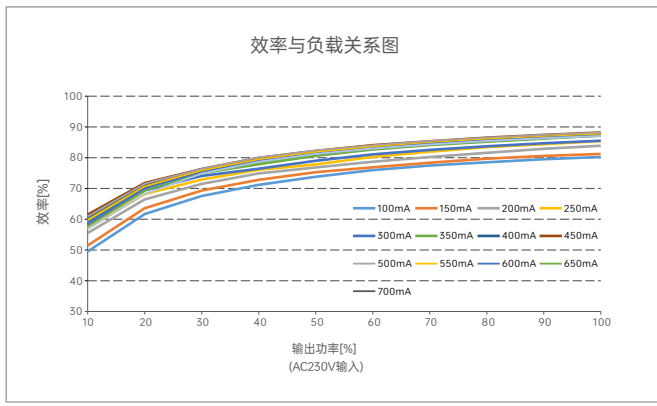

SE-20-100-700-W1MA

频闪测试表

IEEE1789

低 险区域 (LowRisk)的波动深度 (Modulation) 限值	
光输出波形频率 f	限值 (%)
$f \leq 8\text{Hz}$	0.2
$8\text{Hz} < f \leq 90\text{Hz}$	$0.025 \times f$
$90\text{Hz} < f \leq 1250\text{Hz}$	$0.08 \times f$
$f > 1250\text{Hz}$	免除考核
险区域 (NoEffect)的波动深度 (Modulation) 限值	
光输出波形频率 f	限值 (%)
$f \leq 10\text{Hz}$	0.1
$10\text{Hz} < f \leq 90\text{Hz}$	$0.01 \times f$
$90\text{Hz} < f \leq 3125\text{Hz}$	$(0.08/2.5) \times f$
$f > 3125\text{Hz}$	免除考核 (频豁免)

- 亮度
- ▲ 0.1%
 - ◆ 1%
 - ▲ 5%
 - 10%
 - 20%
 - ▲ 30%
 - 40%
 - 50%
 - 60%
 - 70%
 - 80%
 - 90%
 - ◆ 100%

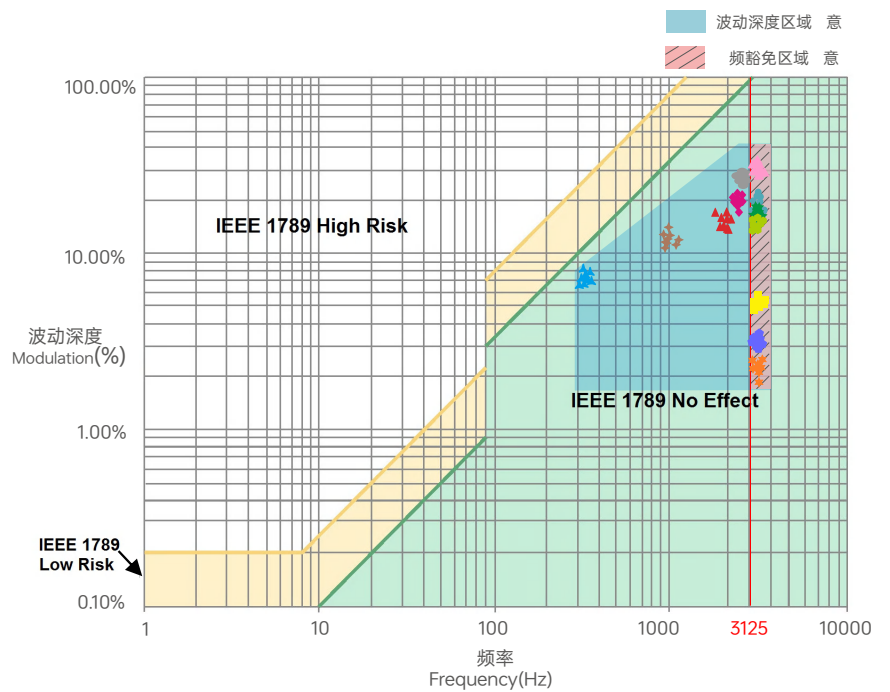

右图标识为不同电流档的测试结果。

100%亮度时输出频率为0Hz, 对应波动深度为0%, 无法在右图中示意。

添加到Matter平台说明

- 1.本设备支持各大主流智能家居平台控制，包括Apple Home、Amazon Alexa、Google Home、SmartThings等。
- 2.要连接Matter over Thread设备，需要准备各大平台支持Thread边界路由功能的Matter中枢，型号可以查看下图。

 Apple Home	 SmartThings	 Google Home	 Amazon Alexa
Apple HomePod (second-gen)	Aeotec SmartThings Smart Home Hub	Google Nest Hub (2nd Gen)	Amazon Echo (4th-gen)
Apple HomePod Mini	Samsung SmartThings Station	Google Nest Hub Max	Amazon Echo Hub
Apple TV 4K (2nd gen)	Samsung SmartThings Hub Dongle	Google Nest Wifi Pro	Amazon Echo Show 8 (3rd-gen)
Apple TV 4K (3rd gen, 128 GB)	Samsung SmartThings Hub v3	Google TV Streamer (4K)	Amazon Eero 6, Pro 6, 6 Plus, Max 7 etc.

3.本说明书以Apple Home为例，请先准备一台装有最新版本固件的 iPhone (iOS 16.2 或更高版本) 或 iPad (iPadOS 16.2 或更高版本)，以及一台装有最新版本固件的 Apple HomePod mini。然后将 iPhone 或 iPad 连接到您的家庭 WLAN 网络，运行 Apple Home 应用程序并按照 Apple 的指示设置 HomePod mini。

*如苹果手机型号是iphone 16及以上，则无需Matter中枢，可直接添加。

添加步骤（以苹果家庭为例）

1.添加配件

打开苹果“家庭”app，并点击“添加或扫描配件”，通过扫描设备上的二维码贴纸，将设备添加到“家庭”APP，如下图所示。

*也可以通过NFC入网：打开“家庭”APP靠近设备的NFC感应区域，识别入网。



2.控制设备

成功添加设备后，点击设备图标进行开/关；点击设备卡片进入亮度控制界面。



3. 高级功能

支持创建组、场景、自动化、进行远程控制和定时控制，也可以通过Siri语音指令控制设备。



4. 多生态配网

如果产品需要加入到两个或者多个生态，可以进入设备设置页，点击“打开配对模式”，获取配对码并添加到第三方平台。

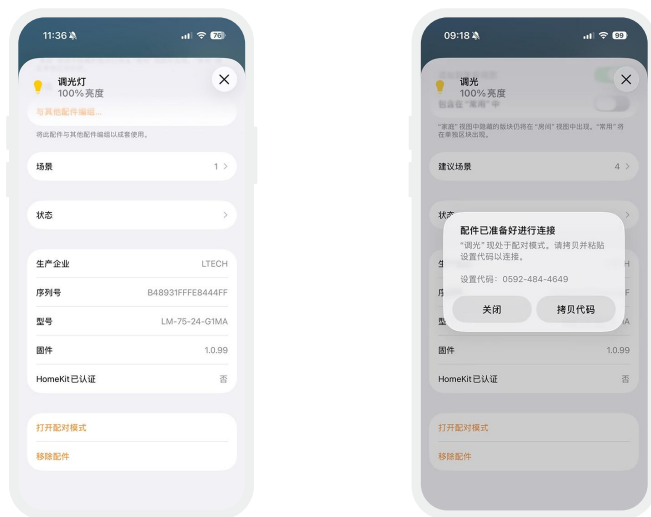

恢复出厂设置

确保设备已接灯且处于常亮状态下，使用开关让设备连续通断电6次(每次断电时间15秒，通电2秒)，第6次通电2秒后，灯具闪烁5次，即表示设备已恢复出厂设置状态。

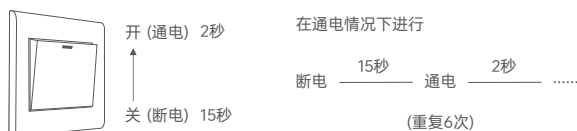

搭配 NFC Lighting APP 使用

通过手机扫描下方二维码，按提示完成APP安装。

(因性能需求，要求手机型号苹果：iPhone 8及以上、且操作系统iOS13及以上； 安卓：具备NFC功能机型)



* 设置驱动器参数时，必须在驱动器断电情况下进行操作。

读/写智能电源

使用手机，通过NFC读取驱动器信息，根据需求设置参数后，可直接写入驱动器。

1. 读取驱动器

在APP“首页”点击【读/写智能电源】，将手机感应区域靠近驱动器NFC感应区，读取驱动器参数。



2. 编辑参数

点击【参数管理】可编辑输出电流、调光渐变时间、通电渐变时间、亮度范围、通电状态等更多高级参数。



3. 写入驱动器

参数设置完成后，点击【写入】，将手机感应区域靠近驱动器NFC感应区，即可写入驱动器成功修改参数。



包装规格

型号	SE-20-100-700-W1MA
包装箱尺寸	372×355×105mm(L×W×H)
数量	32个/层; 2层/箱; 64个/箱
重量	0.11kg/个; 7.4kg±5%/箱

包装样式图

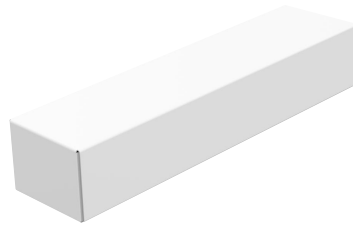

内包装盒



整箱包装

常见问题

本产品遵循Matter协议标准设计，因该协议尚处行业发展初期，受当前版本限制，部分功能、性能及网络连接稳定性存在优化空间。产品表现以当前Matter协议版本为准，我司将随官方版本持续升级并优化产品功能与性能，敬请知悉。

- 1.Matter中枢网关管理的Matter数量多，导致连接不稳定，控制不稳定怎么办？
 - 1.1 建议每台中枢网关添加Matter设备不要超过40台；
 - 1.2 建议中枢网关保持常通电，否则设备重连时间较长；
 - 1.3 不同品牌，不同性能的路由器对Matter中枢管理的设备数量有一定的影响，建议选择性能强大的路由器。
- 2.群组控制开关，调光出现丢包，app出现状态来回跳动清空怎么办？

建议群组数量控制在10台以内。
- 3.长时间不控制设备，设备掉线，无法恢复怎么办？

建议设备断上电重新连接。
- 4.设备恢复出厂设置后，依旧添加设备失败怎么办？

建议断上电后再添加设备。
- 5.常见的路由器原因导致添加设备失败的原因。
 - 5.1 路由器需要开启IPv6选项；
 - 5.2 路由器需要关闭“防暴力破解网络”选项；
 - 5.3 不要连接“访客模式”下的WiFi，需要连接主WiFi。

运输和贮存

1. 运输
产品适用车、船、飞机交通运输工具运输。
在运输中，应使用遮篷进行防雨和防晒，并保持文明装卸，不应有剧烈振动、撞击等。
2. 贮存
贮存符合I类环境的规定。贮存期限超过6个月的产品建议重新检验，合格后方可使用。

注意事项

- 请由具有专业资格的人员进行调试安装；
 - 雷特产品(专有型号除外)不能防水,需避免日晒雨淋,如安装在户外,请用防水箱;
 - 良好的散热条件会延长产品的使用寿命,请把产品安装在通风良好的环境;
 - 请检查使用的工作电压是否符合产品的参数要求;
 - 使用的电线直径大小必须能够负载连接的LED灯具,并确保接线牢固;
 - 通电调试前,应确保所有接线正确,以避免因接线错误而导致灯具损坏;
 - 如果发生故障,请勿私自维修;如有疑问,请联系供应商。
- * 本说明书的内容如有变更,恕不另行通知。若内容与您使用的功能有所不同,则以实物为准。如有疑问,欢迎向我司授权的经销商咨询。

保修条例

- 自出厂之日起保修服务期为5年。
 - 在保修服务期内出现产品质量问题雷特科技将给予免费修理或更换服务。
- 非保修条例:
- 属下列情况不在免费保修或更换服务范围之内:
- 已经超出保修服务期;
 - 过高电压、超负载、操作不当等人为造成的损坏;
 - 产品外形严重损坏或变形;
 - 自然灾害以及人力不可抗拒原因造成的损坏;
 - 产品保修标签和产品唯一条形码损坏;
 - 无雷特科技签订的合同或发票凭证。
1. 修理或更换是雷特科技对客户的一补救措施。雷特科技不承担任何附带引起的损害赔偿,除非在适用法律范围之内。
 2. 雷特科技享有修正或调整本保修条款的权利,并以书面形式发布为准。