

Intelligent Full Color RGBW LED Driver (Constant Voltage)

- Small size and light weight. The housing is made from V0 flame retardant PC materials that SAMSUNG/COVESTRO uses.
- The clamshell design and screwless type for strain-relief. The design of dismountable end cap allows you to adjust the length of housing depending on your needs.
- Bluetooth 5.0 SIG Mesh with high networking capability is reliable and stable.
- Gain control on iOS or Android devices through Bluetooth connection.
- With soft-on and fade-in dimming function, enhancing your visual comfort.
- Dimming from 0~100%, down to 0.0001%.
- Comply with the EU's ErP Directive, standby power consumption<0.5W.
- The secure and reliable design for signal isolation.
- Innovative thermal management technology intelligently protects the life of the LED driver.
- Overheat, over voltage , overload, short circuit protection and automatic recovery.
- Up to 50,000-hour life time.
- 5-year warranty (Rubycon capacitor).



Flicker-Free
IEEE 1789

Dimmable:
1:1000000



RoHS

SELV



The certification icon represents on-going certification applications only, and final certification qualification is subject to actual products.

Technical Specs

Model	LM-150-24-G4B1			
Features	Output Type	Constant Voltage		
	Dimming Interface	Bluetooth 5.0 SIG Mesh		
	Output Feature	Isolation		
	Protection Grade	IP20		
	Insulation Grade	Class II [Suitable for class I /II/III light fixtures]		
OUTPUT	Output Voltage	24Vdc		
	Output Voltage Range	24Vdc ± 0.5Vdc		
	Output Current	Max. 6.25A (1.56Ax4CH)		
	Output Power	Max. 150W		
	Output Power Range	0~150W		
	Strobe Level	High frequency exemption level		
	Dimming Range	0~100%, down to 0.0001%		
	Overload Power Limitation	≥102%		
INPUT	Ripple	Switch ripple≤150mV, noise≤300mV		
	PWM Frequency	3600Hz		
	DC Voltage Range	200-280Vdc		
	AC Voltage Range	198-264Vac		
	Rated Voltage	220-240Vac		
	Frequency	50/60Hz		
	Input Current	≤0.75A/230Vac		
	Power Factor	PF>0.98/230Vac (at full load)		
	THD	THD<6%@230Vac (at full load)		
	Efficiency (typ.)	93%		
	Standby power consumption	<0.5W		
ENVIRONMENT	Inrush Current	Cold start 45A@230Vac (Test twidth=840us tested under 50% Ipeak)		
	Anti Surge	L-N: 2KV		
	Leakage Current	Max. 0.5mA		
	Working Temperature	ta: -20 ~ 50°C tc: 85°C		
	Working Humidity	20 ~ 95%RH, non-condensing		
PROTECTION	Storage Temperature/Humidity	-40 ~ 80°C, 10~95%RH		
	Temperature Coefficient	±0.03%/°C [0-50°C]		
	Vibration	10~500Hz, 2G 12min/1cycle, 72 min for X, Y and Z axes respectively		
	Overheat Protection	Intelligently adjust or turn off the output current if the PCB temperature ≥110°C, and recover automatically		
	Overload Protection	Shut down the output when current load≥102%, and recover automatically		
SAFETY & EMC	Short Circuit Protection	Enter hiccup mode if short circuit occurs, and recover automatically		
	Overvoltage Protection	Shut down the output when non-load voltage≥28V, and recover automatically		
	Withstand Voltage	I/P-O/P: 3750Vac		
	Isolation Resistance	I/P-O/P: 100MΩ/500VDC/25°C/70%RH		
	Safety Standards	CCC	China	GB19510.1, GB19510.14
		CE	European Union	EN61347-1, EN61347-2-13, EN62384, EN61547
	EMC Emission	CCC	China	GB/T17743, GB17625.1
CE		European Union	EN55015, EN61000-3-2, EN61000-3-3, EN61547	
EMC Immunity	EN61000-4-2,3,4,5,6,8,11, EN61547			
Strobe Test Standard	IEEE 1789			
OTHERS	Gross weight[G.W]	430g±10g		
	Dimensions	352×43×30mm(L×W×H)		

The driver is suitable for connecting resistor current-limiting LED fixture (e.g. LED strip). The inrush current will be dozens of times increased if connecting built-in constant current IC current-limiting LED fixtures, the driver will activate the overloaded protection (hiccup flickering). When you order, please remark controlling the constant current LED fixture (e.g. MR16 lamp, underground light, LED wall washer, constant current LED strip, etc.), so that we can prepare them with special procedures.

Product Size

Unit: mm

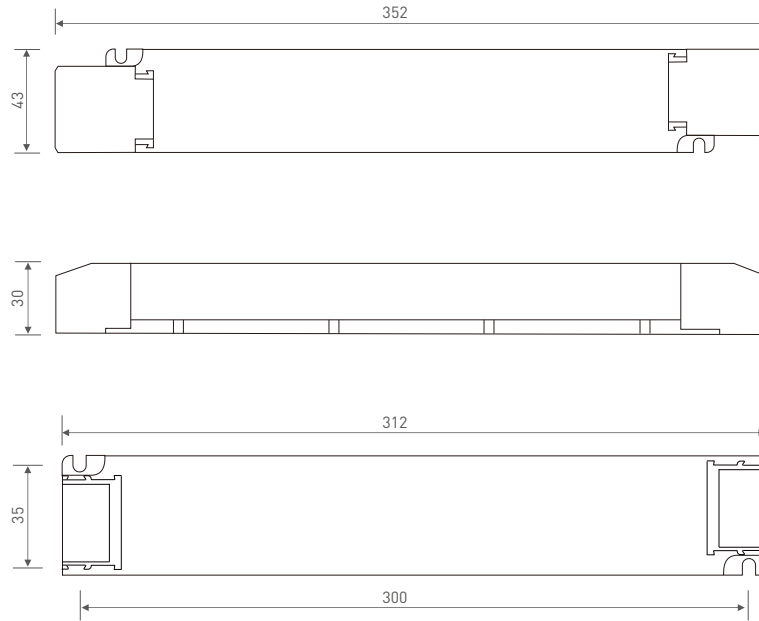

Wiring Diagram

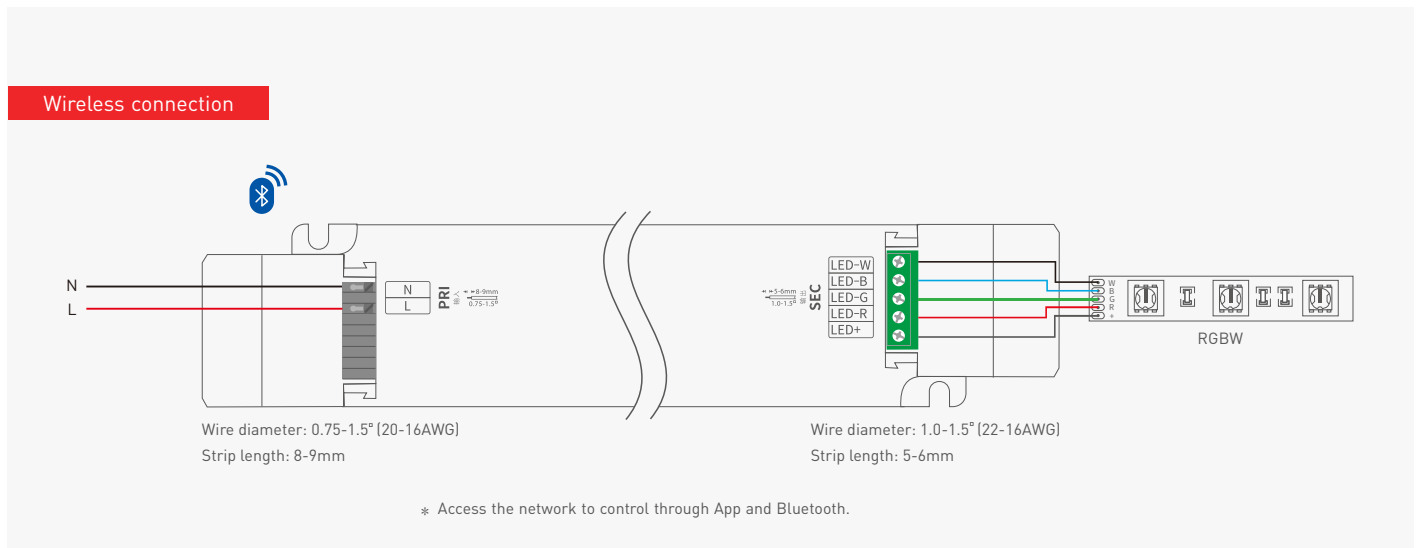

Protective Housing Application Diagram

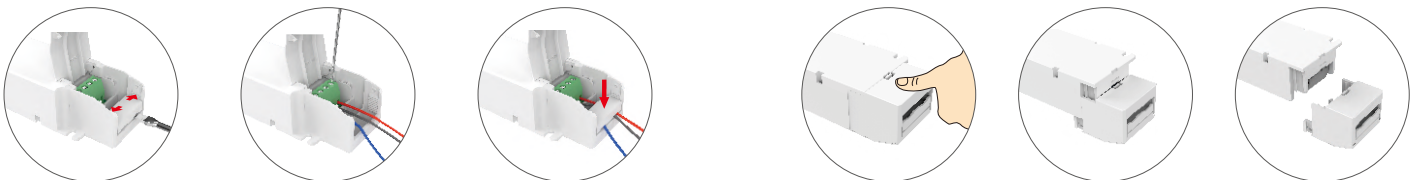

Open the protective housing and push the side housing outwards to pry up the wire fixing board with a screwdriver . Then connect to electrical wires as wiring diagram shows. Press down the wire fixing board to fix the the electrical wires, finally close the protective housing.

Press down the back side of the protective housing and move it from side to side to remove it.

Relationship Diagrams

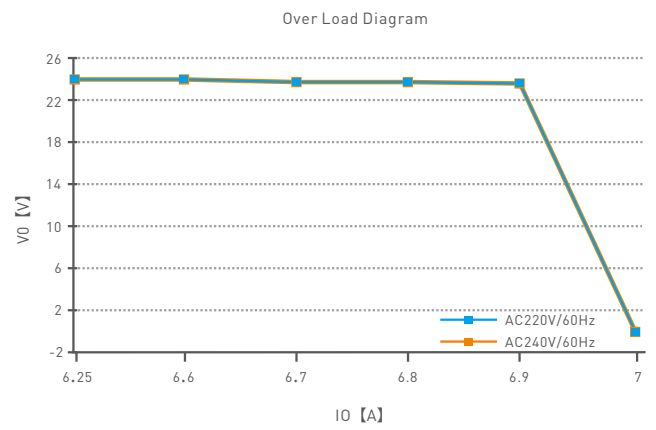
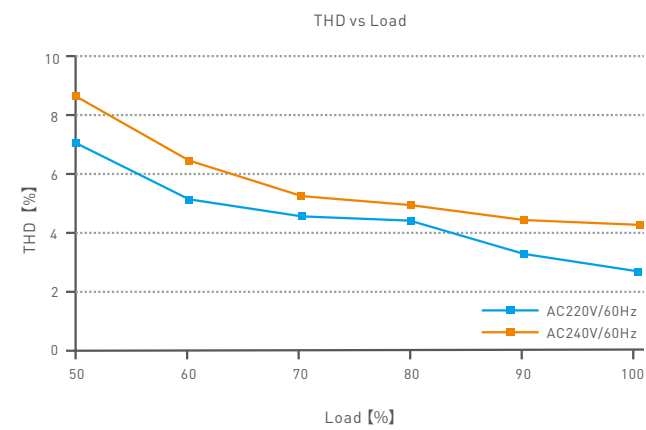
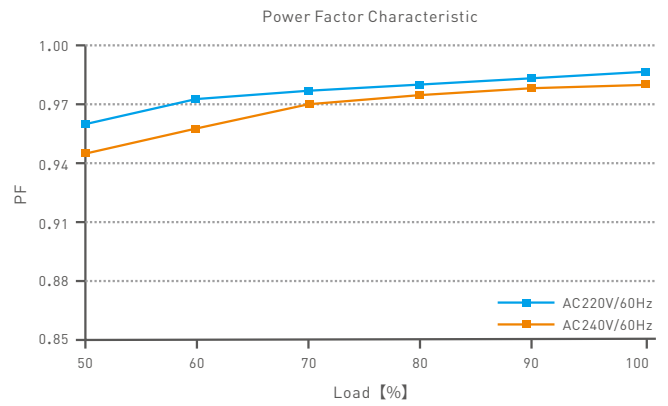
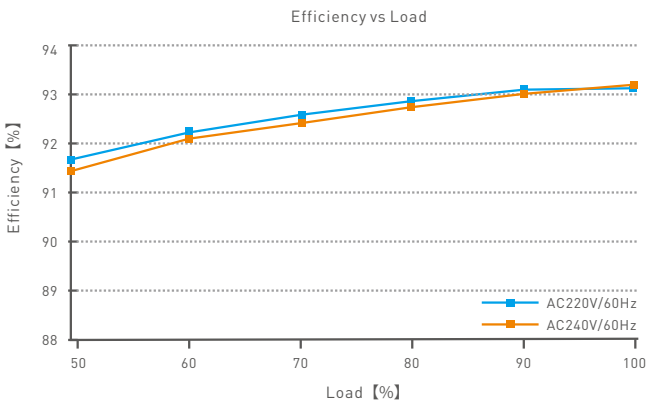

Flicker Test Table

Limit Value of Modulation in Low Risk Areas	
Waveform frequency of optical output (f)	Limit value (%)
$f \leq 8\text{Hz}$	0.2
$8\text{Hz} < f \leq 90\text{Hz}$	$0.025 \times f$
$90\text{Hz} < f \leq 1250\text{Hz}$	$0.08 \times f$
$f > 1250\text{Hz}$	Exemption assessment
Limit Value of Modulation in No Effect Areas	
Waveform frequency of optical output (f)	Limit value (%)
$f \leq 10\text{Hz}$	0.1
$10\text{Hz} < f \leq 90\text{Hz}$	$0.01 \times f$
$90\text{Hz} < f \leq 3125\text{Hz}$	$[0.08/2.5] \times f$
$f > 3125\text{Hz}$	Exemption assessment (High frequency exemption)

- Brightness**
- ▲ 0.1%
 - ◆ 1%
 - ▲ 5%
 - ◆ 10%
 - 20%
 - ▲ 30%
 - 40%
 - ★ 50%
 - 60%
 - 70%
 - 80%
 - ★ 90%
 - ◆ 100%

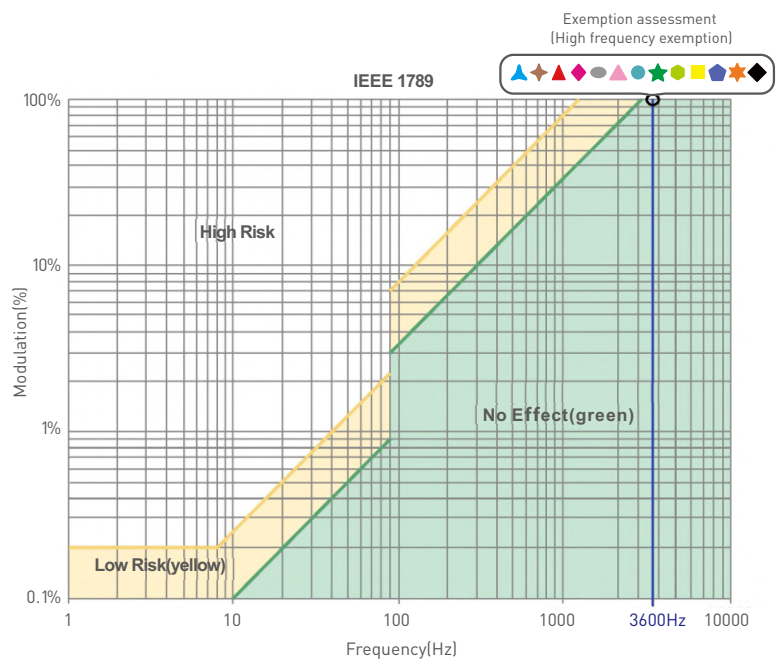

Marks in the right chart are tested results of different current levels. The output frequency is 0Hz in 100% brightness and its corresponding modulation is 0%, which could not be shown in the right chart.

System Diagram

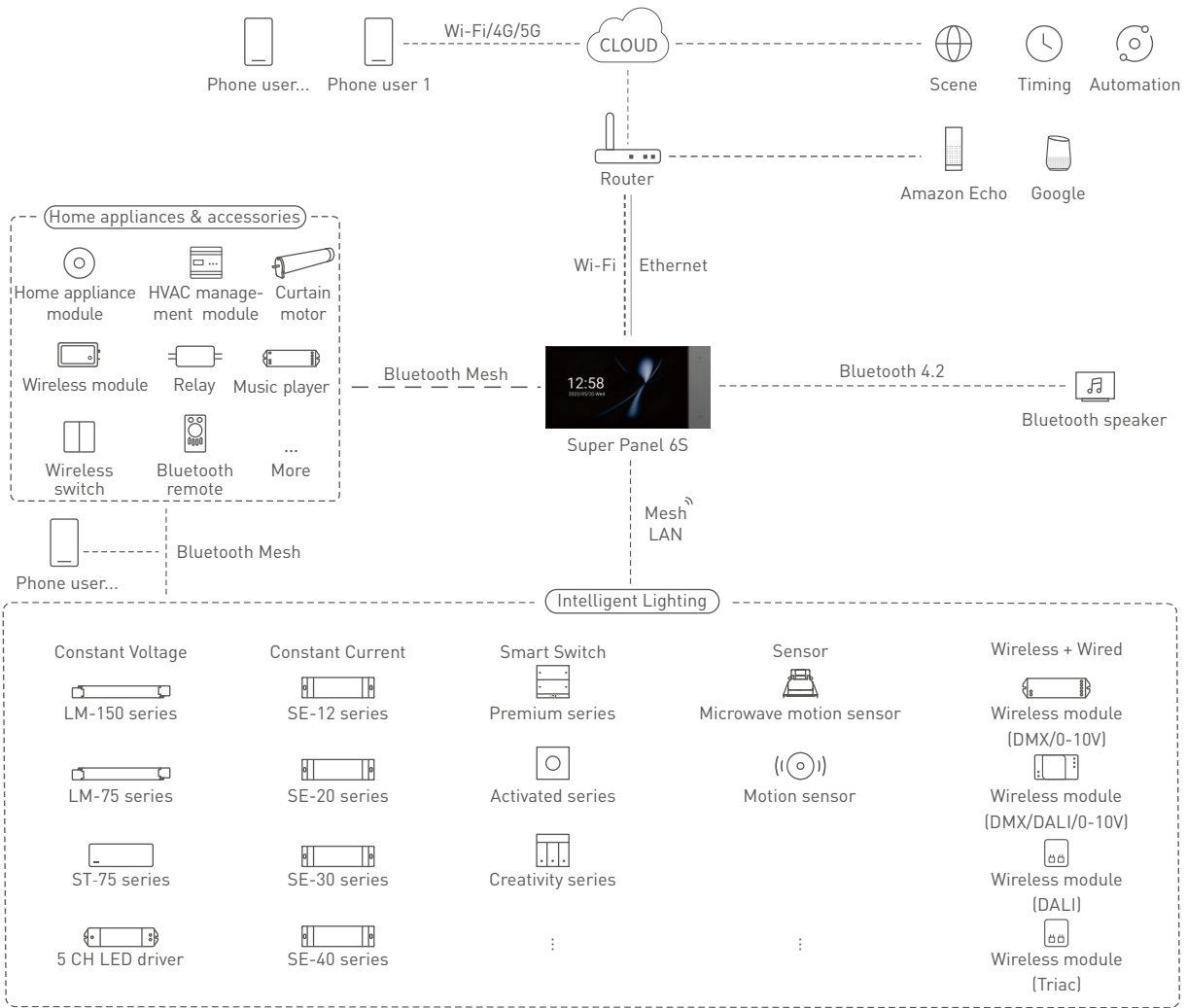

Recommend Applications

1. Achieve fast dimming control.

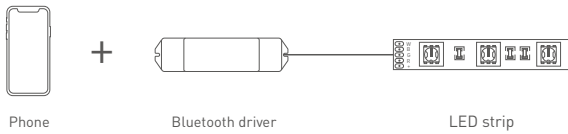

2. Both App and remote can control the driver after connecting the remote to the driver with App.

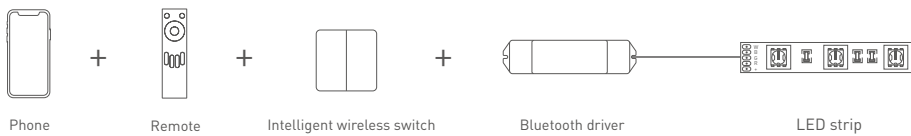

3. Both App and Super Panel 6S can control the driver simultaneously after connecting the Super Panel 6S to the driver with App. By connecting the Super Panel to network, you are allowed to control the driver, cloud scenes and automation remotely with App.

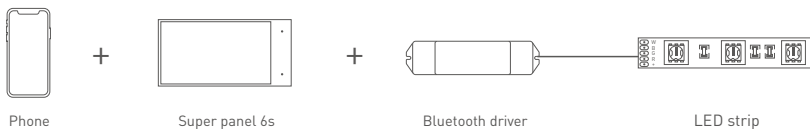

4.More applications of intelligent control are waiting for you to set up.

App Operating Instructions

1. Register an account

The App is available on iOS or Android devices. Scan the QR code below with you mobile phone and follow the prompts to complete the App installation. Open the App to log in or register an account.



Scan and download the APP

2. Paring instructions

Open the APP and create a home if you are a new user. Click "+" icon in the upper right corner and access the "Add Device" list, Pick "Smart lighting-RGBW light[BLE]" from the list and follow the prompts to power on the device firstly. Make sure the device is not connected to the network. Then click "Bluetooth Search" and follow the prompts to add the device.

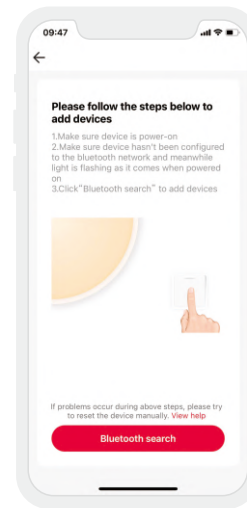
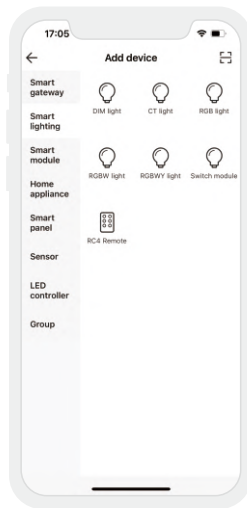
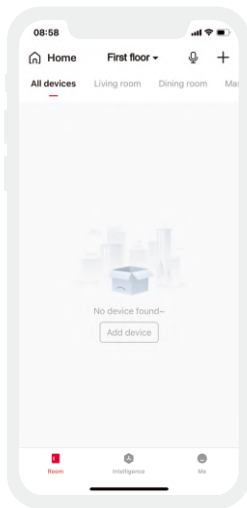

3. Control interface settings

After pairing up your device, go to the control interface. You'll be able to achieve your desired lighting effects by changing brightness and color temperature and colors. Click "Theme" and you'll easily switch to multiple theme lighting effects with one tap. Click "Mode" and the App provides you editable advanced modes. Customize dynamic modes to put you into a more colorful life.

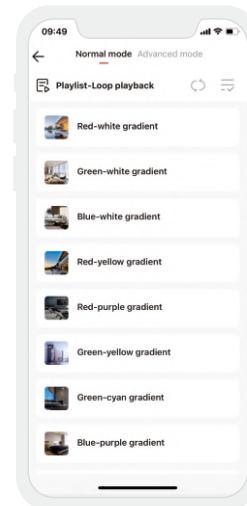
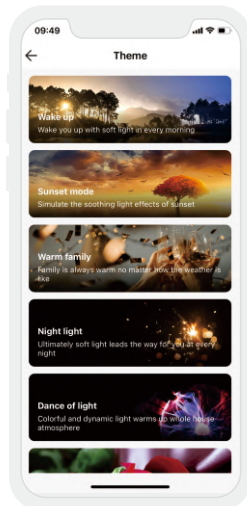
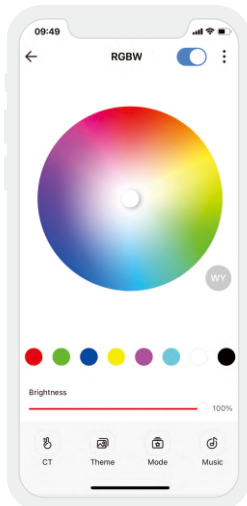

4. Light groups

Users are able to combine the same type of light fixtures into a group to control them simultaneously. Once you create the group, you can set the dim level and adjust the color of lights more easily. Pick "Group-RGBW light group" from the list. Follow the prompts to rename the group and click "Next" to pick the lights you are going to group together and click "Save".

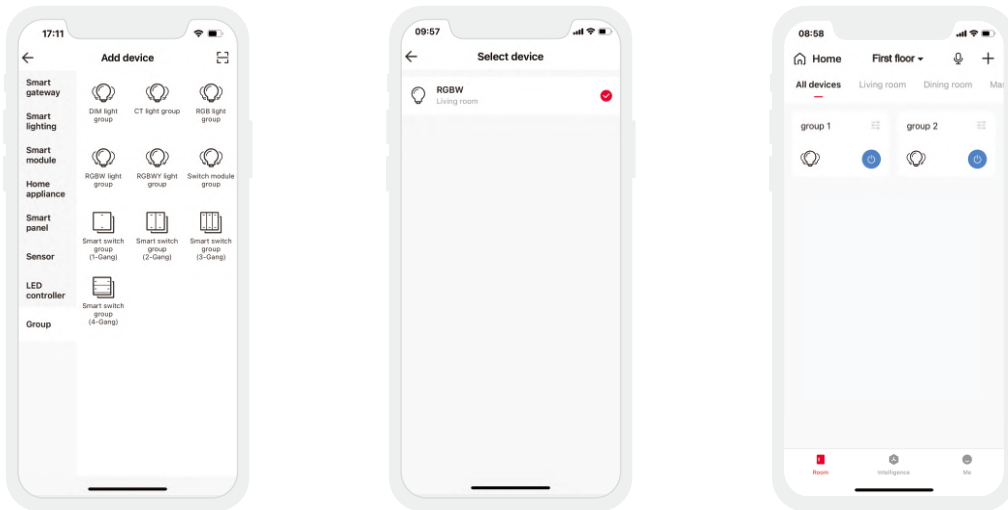

5. Advanced functions

This driver can be linked up with gateway function devices (such as Super Panel 6S) to achieve the advanced functions from local scenes and cloud scenes to automation.

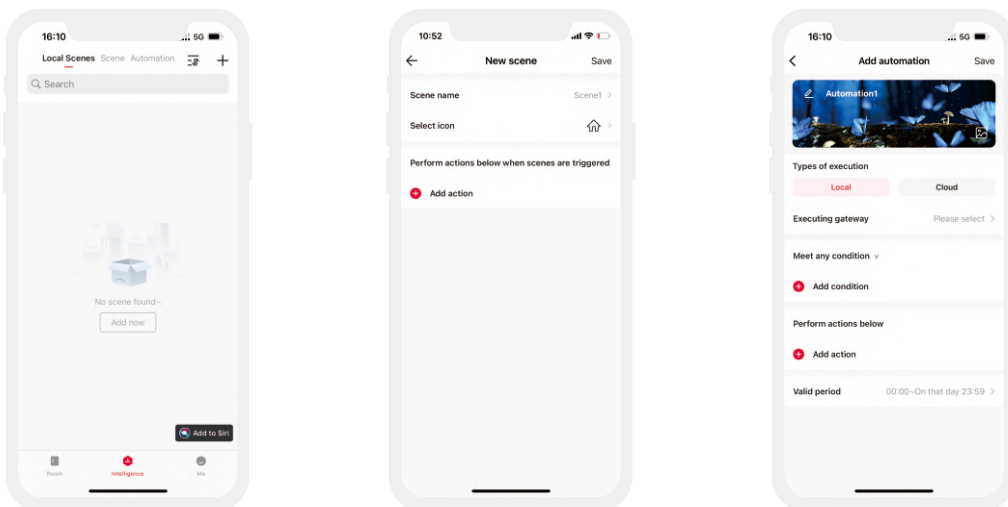

Reset The Device (Reset to factory defaults)

Make sure the driver is well-connected to a lamp and the lamp is on, turn it off with the switch and after 15s turn it on. After 2s, turn it off again. Repeat the same operation 6 times. When the lamp flashes 5 times, reset the device to factory defaults successfully.

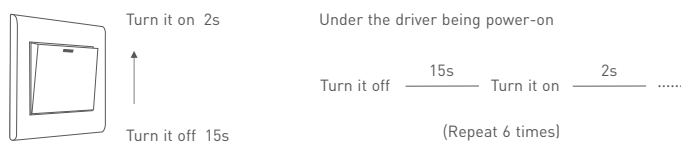

Packaging Specifications

Model	LM-150-24-G4B1
Carton Dimensions	370x340x93mm[LxWxH]
Quantity	10 PCS/Layer; 2 Layers/Carton; 20 PCS/Carton
Weight	0.43 kg/PC; 9.4 kg/Carton

Packaging Image



Inner Packaging Box



Carton Packaging

Transportation and Storage

1. Transportation

Products can be shipped via vehicles, boats and planes.

During transportation, products should be protected from rain and sun. Please avoid severe shock and vibration during the loading and unloading process.

2. Storage

The storage conditions should comply with the Class I Environmental Standards. The products that have been stored for more than six months are recommended to be re-inspected and can be used only after they have been qualified.

FAQs

1. What should I do if I fail to add the device?
 - 1.1 Please make sure the device is powered on normally and is in the activated mode.
 - 1.2 Please make sure the device hasn't been added by any other account. If it did, please reset to factory defaults manually.
 - 1.3 The recommended distance between the mobile phone and the device is no more than 20 meters.
 - 1.4 If the device has been forced to delete, please reset to factory defaults manually and then add the device again.
2. What should I do if the device disconnects from the network?
 - 2.1 Please make sure the device is powered on normally.
 - 2.2 Please make sure the router works normally and the network runs smoothly.
 - 2.3 If you control the device remotely, please make sure your phone network runs smoothly.
3. How to control remotely and set cloud scenes?

Remote control and cloud scenes can be achieved only by working with LTECH Super Panel.
4. How to share control of your home devices?

Please go to "Me" - "Home Management" and access the home you want to share. Click "Add Member" and follow the prompts to add members into your home.

Attentions

- This product must be installed and adjusted by a qualified professional.
 - This product is non-waterproof (special models excepted). Please avoid the sun and rain. When installed outdoors, please ensure it is mounted in a water proof enclosure.
 - Good heat dissipation will extend the life of the product. Please install the product in an environment with good ventilation.
 - When you install this product, please avoid being near a large area of metal objects or stacking them to prevent signal interference.
 - Please keep the product away from an intense magnetic field, a high pressure area or a place where lightning is easy to occur.
 - Please check whether the working voltage used complies with the parameter requirements of the product.
 - Before you power on the product, please make sure all the wiring is correct in case of incorrect connection that may cause a short circuit and damage the components, or trigger an accident.
 - If a fault occurs, please do not attempt to fix the product by yourself. If you have any question, please contact the supplier.
- * This manual is subject to changes without further notice. Product functions depend on the goods. Please feel free to contact our official distributors if you have any question.

Warranty Agreement

- Warranty periods from the date of delivery: 5 years.
- Free repair or replacement services for quality problems are provided within warranty periods.

Warranty exclusions below:

- Beyond warranty periods.
- Any artificial damage caused by high voltage, overload, or improper operations.
- Products with severe physical damage.
- Damage caused by natural disasters and force majeure.
- Warranty labels and barcodes have been damaged.
- No any contract signed by LTECH.

1. Repair or replacement provided is the only remedy for customers. LTECH is not liable for any incidental or consequential damage unless it is within the law.
2. LTECH has the right to amend or adjust the terms of this warranty, and release in written form shall prevail.

Update Log

Version	Updated Time	Update Content	Updated by
A0	2021.09.13	Original version	Liu Weili
A1	2022.02.28	Update output terminal wire diameter and stripping length	Liu Weili
A2	2023.03.15	The warranty period is changed to 5 years	Liu Weili
A3	2024.06.07	Updated silk screen to the latest version and removed corresponding certification icons	Li Siyu
A4	2025.11.15	Update company logo and silkscreen printing	Haipeng Li