

Intelligent LED Driver (Constant Voltage)

- The housing is made from V0 flame retardant PC materials from SAMSUNG/COVESTRO.
- The clamshell design and screwless type for strain-relief. The design of dismountable end cap allows you to adjust the length of housing depending on your needs.
- Change the dimming method, PWM frequency and other parameters via the APP.
- Bluetooth 5.0 SIG Mesh with high networking capability are reliable and stable.
- Support control iOS or Android devices through Bluetooth connection.
- With soft-on and fade-in dimming function, enhancing your visual comfort.
- The whole dimming process is flicker-free with high frequency exemption level.
- Dimming from 0-100%, down to 0.0001%.
- Comply with the EU's ErP Directive, networked standby<0.5W.
- Overheat, over voltage, overload, short circuit protection and automatic recovery.
- Suitable for Class I/II/III indoor light fixtures.
- Normal service life can reach 100,000 hours.
- 5-year warranty (Rubycon capacitor).



T-PWM
Dimming Technology

Flicker Free
IEEE 1789



Dimmable:
1:1000000



The certification icon represents undergoing certification applications only, and final certification qualification subject to actual product.



Technical Specs

Model		LM-240-24-G2B		
Features	Output Type	Constant voltage		
	Dimming Interface	Bluetooth 5.0 SIG Mesh		
	Output Feature	Isolation		
	Protection Grade	IP20		
	Insulation Grade	Class II (Suitable for class I / II / III light fixtures)		
OUTPUT	Output Voltage	24Vdc		
	Output Voltage Range	24Vdc±0.5Vdc		
	Output Current	Max. 10A		
	Output Power	Max. 240W		
	Dimming Range	0-100%, down to 0.0001%		
	Ripple(maximum)	200mVp-p		
	Voltage Accuracy	±5%		
	PWM Frequency	≤22000Hz [NFC setting range 300-22000Hz]		
INPUT	DC Voltage Range	200-250Vdc		
	AC Voltage Range	220-240Vac		
	EoFv	EoFv=99.6%		
	Input Voltage	220-240Vac		
	Frequency	50/60Hz		
	Input Current	Max. 1.18A/230Vac		
	Power Factor	PF>0.99/230Vac, at full load		
	THD	THD≤5%@230Vac, at full load		
	Efficiency [Typ.]	94%		
	Inrush Current	Cold start 55A[Test twidth=1200us tested under 50% Ipeak]/230Vac		
Anti Surge	L-N: 2KV			
Leakage Current	Max. 0.5mA			
ENVIRONMENT	Working Temperature	ta: -20 ~ 45°C tc: 86°C		
	Working Humidity	20 ~ 95%RH, non-condensing		
	Storage Temperature/Humidity	-40 ~ 80°C/10-95%RH		
	Temperature Coefficient	±0.03%/°C[0-50°C]		
	Vibration	10-500Hz, 2G 12min/1cycle, 72 min for X, Y and Z axes respectively		
PROTECTION	Overload Protection	Shut down the output when rated power≥102%, auto recovers		
	Overheat Protection	Intelligently adjust or turn off the output current if the PCB temperature ≥110°C, and recover automatically		
	Overvoltage Protection	Shut down the output when voltage≥28V, and recover automatically		
	Short Circuit Protection	Enter hiccup mode if short circuit occurs, and recover automatically		
SAFETY & EMC	Withstand Voltage	I/P-O/P: 3750Vac		
	Insulation Resistance	I/P-O/P: 100MΩ/500VDC/25°C/70%RH		
	Safety Standards	CCC	China	GB19510.1, GB19510.14
		TUV	Germany	EN61347-1, EN61347-2-13, EN62493
		CB	CB Member States	IEC61347-1, IEC61347-2-13
		CE	European Union	EN61347-1, EN61347-2-13, EN62384
		KC	Korea	KC61347-1, KC61347-2-13
		EAC	Russia	IEC61347-1, IEC61347-2-13
		RCM	Australia	AS 61347-1, AS 61347-2-13
		ENEC	Europe	EN61347-1, EN61347-2-13, EN62384
	UKCA	Britain	BS EN 61347-1, BS EN 61347-2-13, BS EN 62493	
	EMC Emission	CCC	China	GB/T17743, GB17625.1
		CE	European Union	EN55015, EN61000-3-2, EN61000-3-3, EN61547
		KC	Korea	KSC 9815, KSC 9547
		EAC	Russia	IEC62493, IEC61547, EH55015
RCM		Australia	EN55015, EN61000-3-2, EN61000-3-3, EN61547	
UKCA		Britain	BS EN IEC 55015, BS EN IEC 61000-3-2, BS EN 61000-3-3, BS EN 61547	
EMC Immunity	EN61000-4-2,3,4,5,6,8,11, EN61547			
ErP	Power Consumption	Networked standby	<0.5W (After shutdown by command)	
		No-load power consumption	<0.5W (When the lamp is not connected)	
	Flicker/Stroboscopic Effect	IEEE 1789	Meet IEEE 1789 standard/High frequency exemption level	
		CIE SVM	Pst LM≤1.0, SVM≤0.4	
OTHERS	DF	Phase factor	DF≥0.9	
	Weight[N.W.]	555g±10g		
Dimensions	380×49.5×30mm[L×W×H]			

The driver is suitable for connecting resistor current-limiting LED fixture (e.g. LED strip). The inrush current will be dozens of times increased if connecting built-in constant current IC current-limiting LED fixtures, the driver will activate the overloaded protection (hiccup flickering). When you order, please remark controlling the constant current LED fixture (e.g. MR16 lamp, underground light, LED wall washer, constant current LED strip, etc.), so that we can prepare them with special procedures.

Product Size

Unit: mm

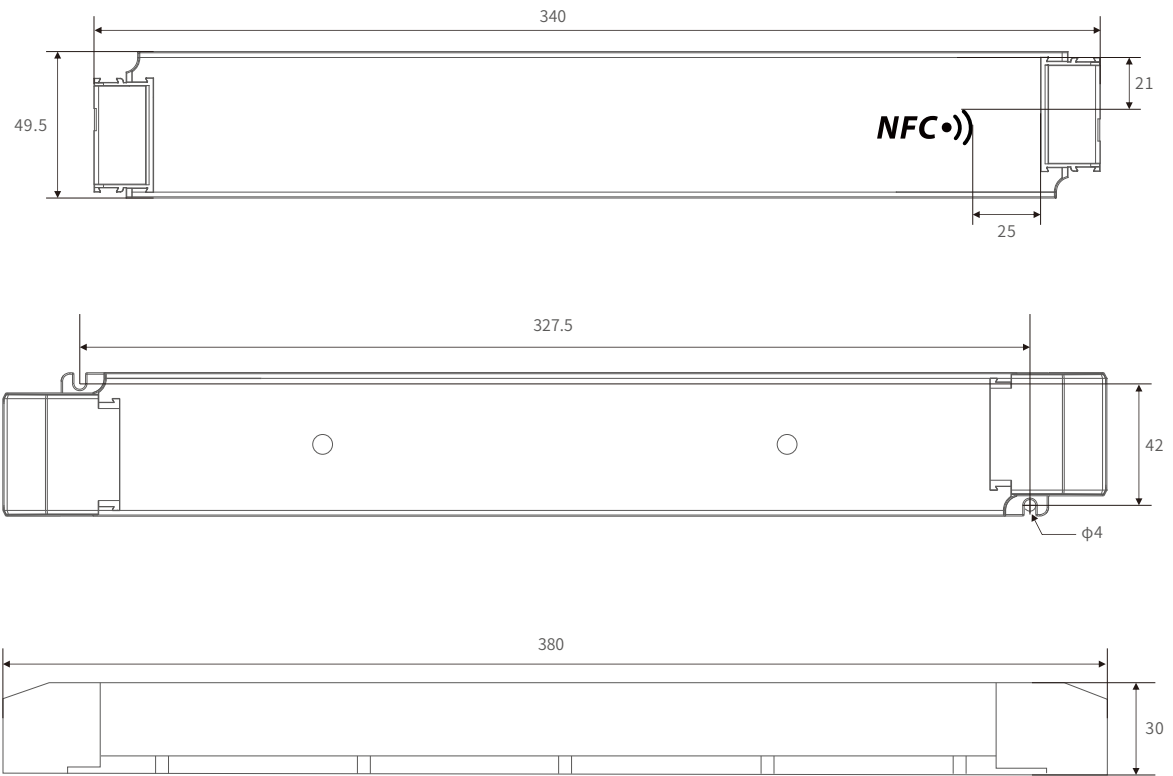

Wiring Diagram

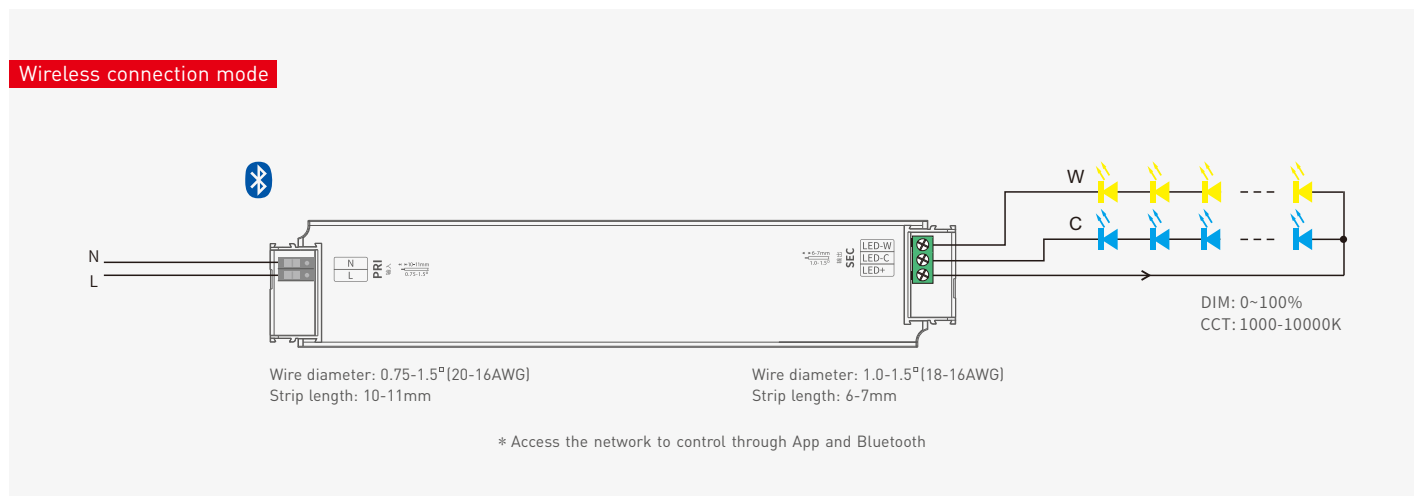

Protective Housing Application Diagram

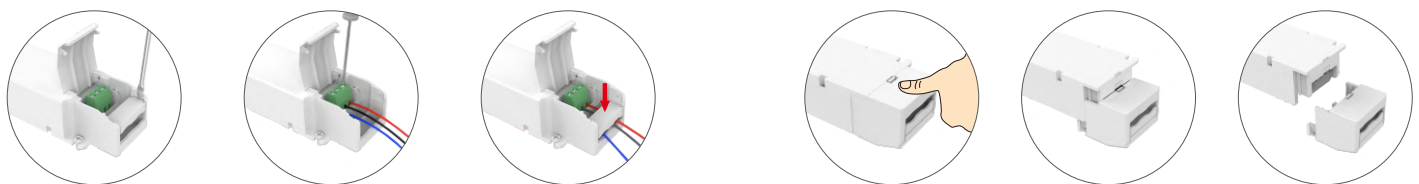

Open the protective housing and push the side housing outwards to pry up the wire fixing board with a screwdriver. Then connect to electrical wires as wiring diagram shows. Press down the wire fixing board to fix the electrical wires, finally close the protective housing.

Press down the back side of the protective housing and move it from side to side to remove it.

Installation Precautions

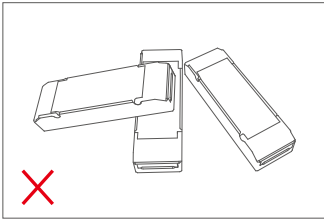

Please do not stack the products. The distance between two products should be $\geq 15\text{cm}$ so as not to affect heat dissipation and the lifespan of the products.

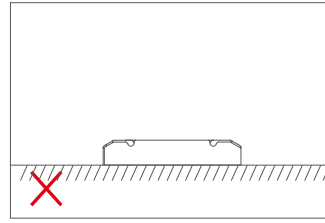
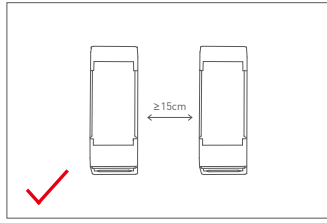

Please do not place the products on the floor. The distance between the product and the floor should be $\geq 100\text{cm}$ so as to avoid signal interference.

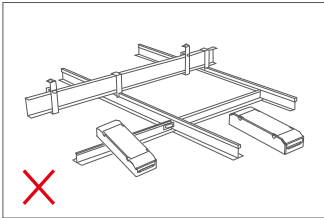
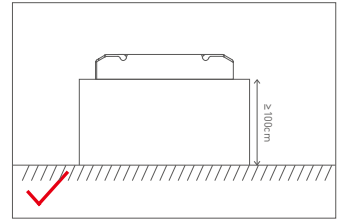

Please do not place the products near a large area of metal objects (such as metal stud ceilings). The distance between the product and the metal object should be $\geq 15\text{cm}$ so as to avoid signal interference.

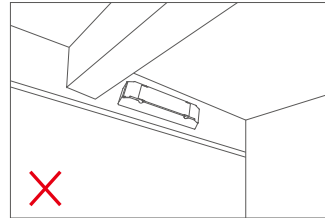
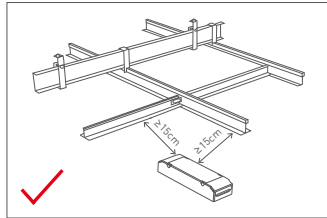

Please do not install the products on beams or near the corners. The distance between the product and the beam or the corner should be $\geq 15\text{cm}$ so as to avoid signal interference.

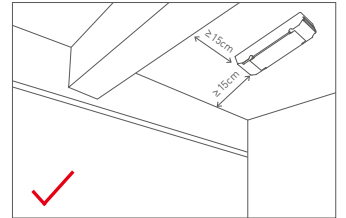

Use the NFC Lighting APP

Scan the QR code below with your mobile phone and follow the prompts to complete the APP installation (According to performance requirements, you need to use a NFC-capable Android phone, or an iPhone 8 and later that are compatible with iOS 13 or higher).



* Before you begin setting the parameters of the driver, please make sure the driver is powered off.

Read/Write the LED driver

Use your NFC-capable phone to read LED driver data, then edit the parameters and they can be directly written to the driver.

1. Read the LED driver

On the APP home page, click [Read/Write LED driver], then keep the programmer's sensing area close to the NFC logo of the driver to read the driver parameters.

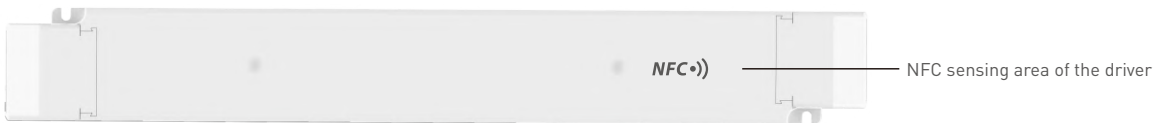

2. Edit the parameters

Click [Parameter settings] to edit the advanced parameters, like output current, like output current, time for fading on/off, power-on status, PWM Frequency etc.

3. Write to the driver

After completing the parameter settings, click [Write] in the upper right corner, and keep the programmer's sensing area close to the NFC sensing area of the driver, so the parameters can be written to the driver.

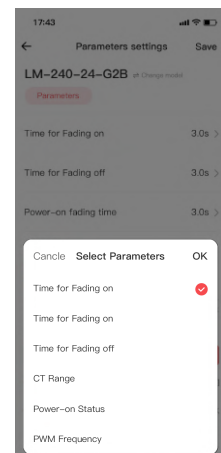
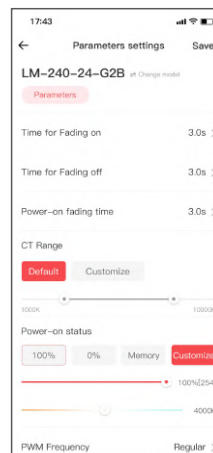
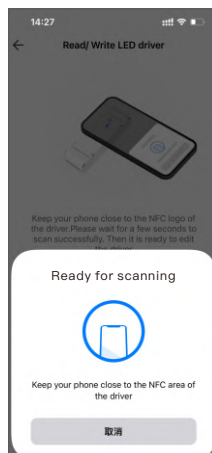

Recommend Applications

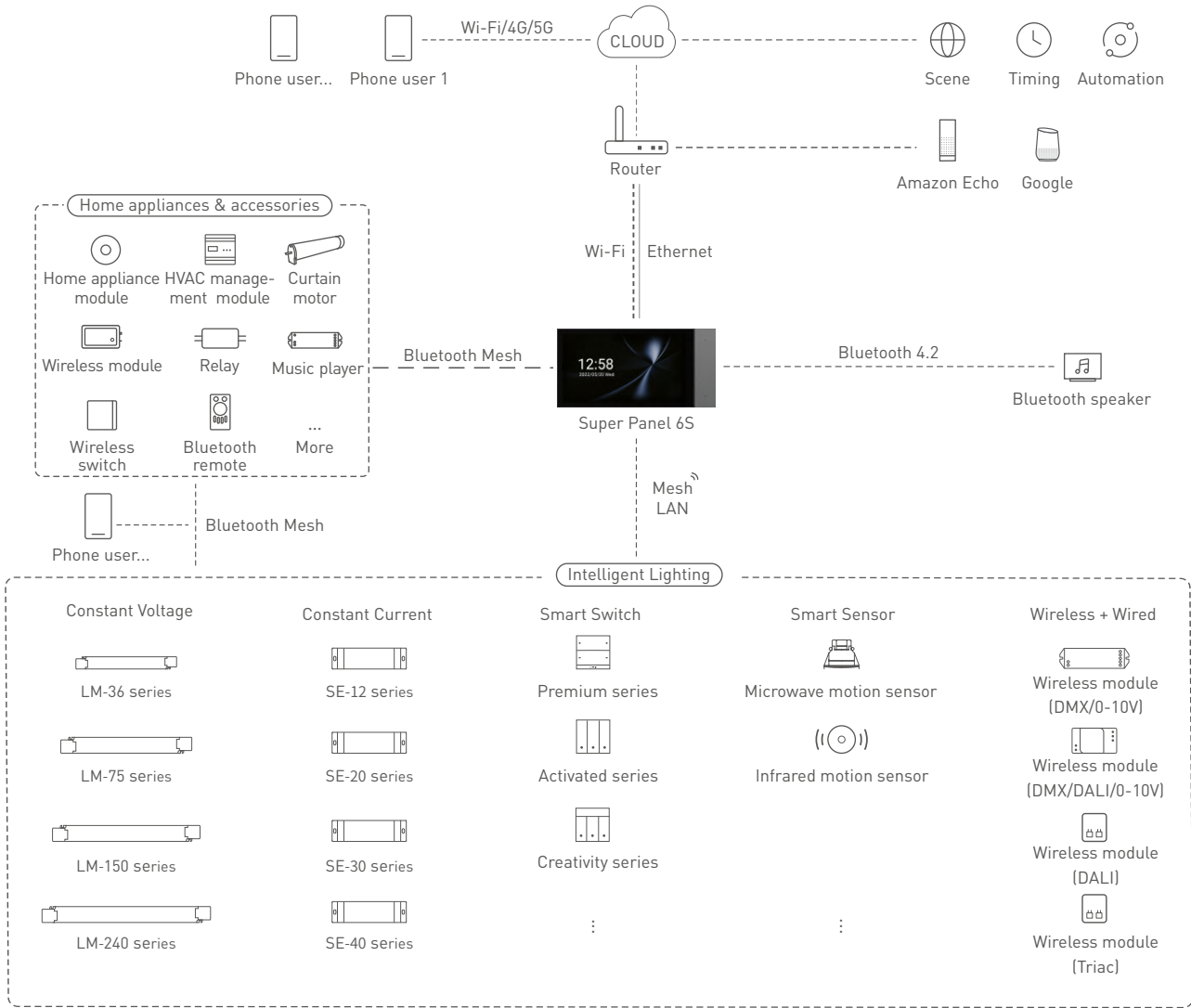

Recommend Applications

1. Achieve fast dimming control.

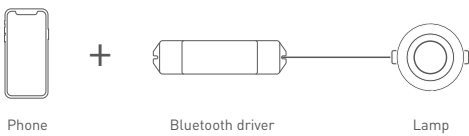

2. Both App and remote can control the driver after connecting the remote to the driver with App.

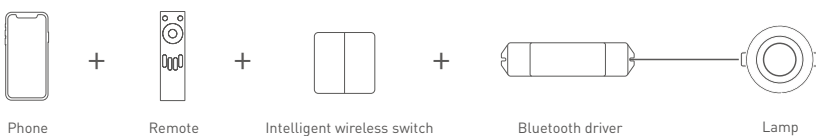

3. Both App and Super Panel 6S can control the driver simultaneously after connecting the Super Panel 6S to the driver with App. By connecting the Super Panel to network, you are allowed to control the driver, cloud scenes and automation remotely with App.



4.More applications of intelligent control are waiting for you to set up.

Use with Bluetooth L-Home APP

1. Register an account

The App is available on iOS or Android devices. Scan the QR code below with you mobile phone and follow the prompts to complete the App installation. Open the App to log in or register an account.



2. Paring instructions

Open the APP and create a home if you are a new user. Click "+" icon in the upper right corner and access the "Add Device" list, then follow the prompts to add the device. Pick "Smart lighting-DIM light" from the list and follow the prompts to power on the device firstly. Make sure the device is not connected to the network. Then click "Bluetooth Search" and follow the prompts to add the device.

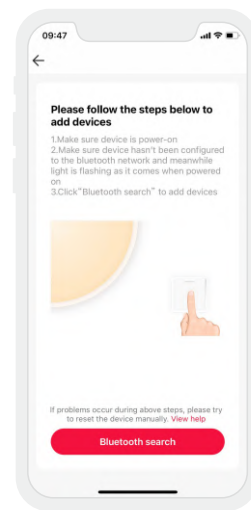
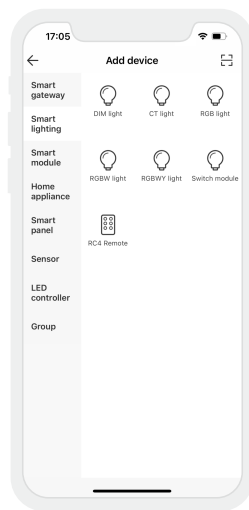
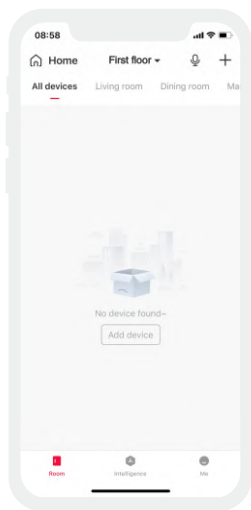

3. Control interface settings

After pairing up your device, go to the control interface. You'll be able to achieve your desired lighting effects by changing brightness and color temperature. Click "Theme" and you'll easily switch to multiple theme lighting effects with one tap. Click "Mode" and the App provides you editable advanced modes. Customize dynamic modes to put you into a more colorful life.

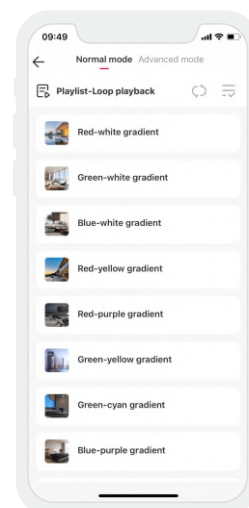
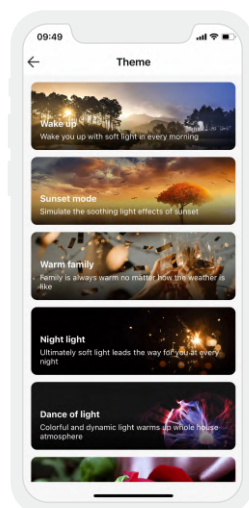
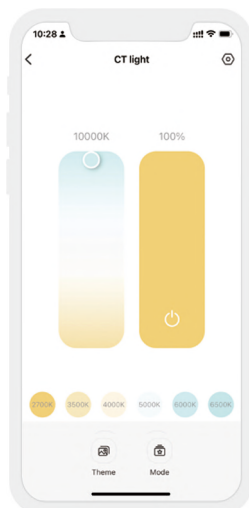

4. Light groups

Users are able to combine the same type of light fixtures into a group to control them simultaneously. Once you create the group, you can set the dim level more easily. Pick "Group-DIM light group" from the list. Follow the prompts to rename the group and click "Next" to pick the lights you are going to group together and click "Save".

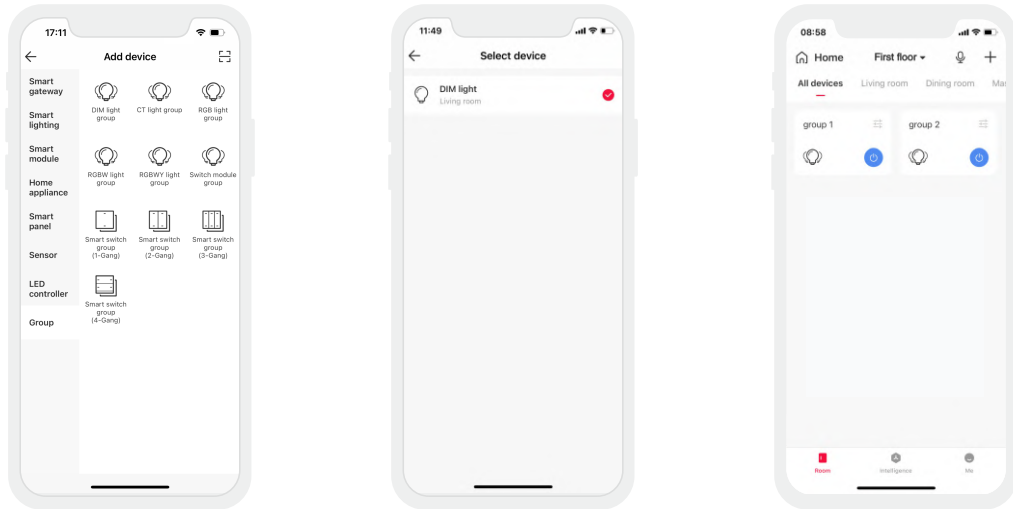

5. Advanced functions

This driver can be linked up with gateway function devices (such as Super Panel 6S) to achieve the advanced functions from local scenes and cloud scenes to automation.

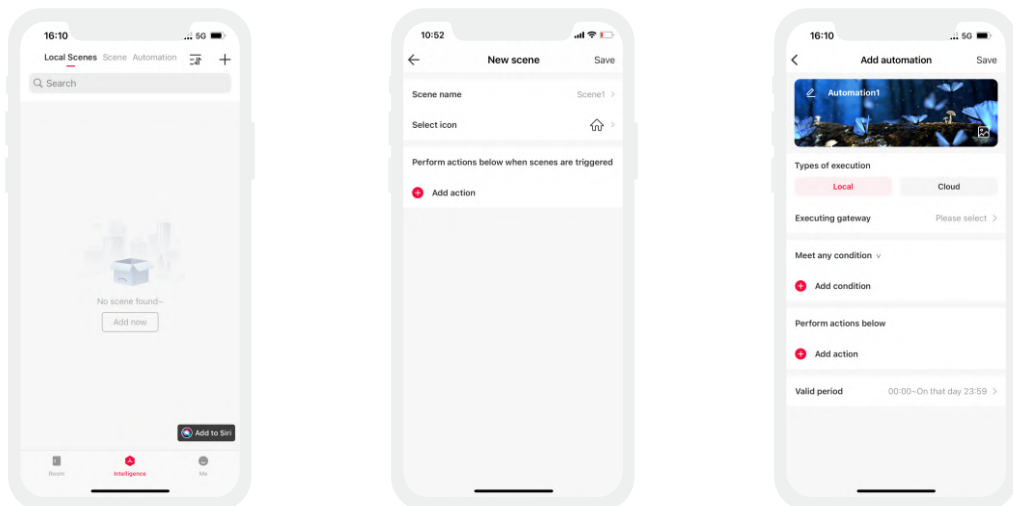

Reset The Device (Reset to factory defaults)

Make sure the driver is well-connected to a lamp and the lamp is on, turn it off with the switch and after 15s turn it on. After 2s, turn it off again. Repeat the same operation 6 times. When the lamp flashes 5 times, reset the device to factory defaults successfully.

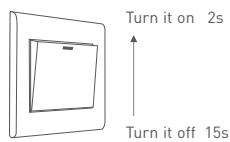

Under the driver being power-on

Turn it off $\xrightarrow{15s}$ Turn it on $\xrightarrow{2s}$
(Repeat 6 times)

Relationship Diagrams

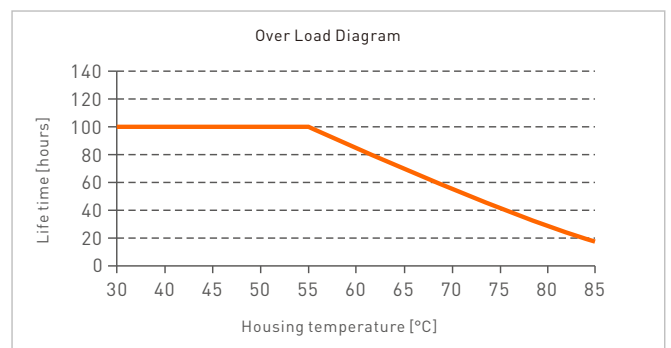
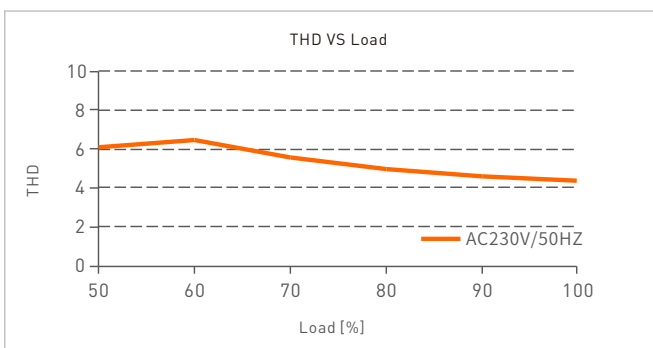
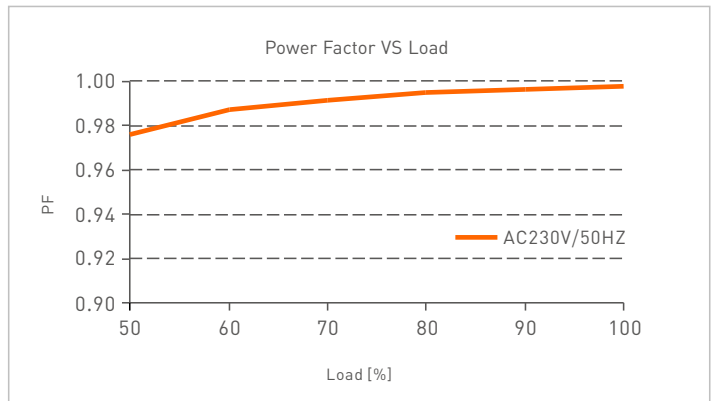
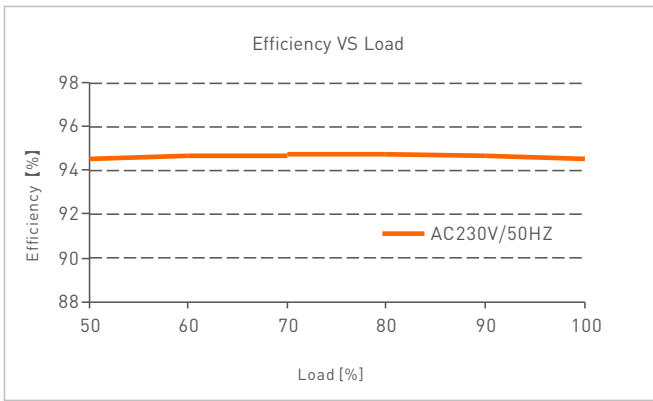

Flicker Test Form

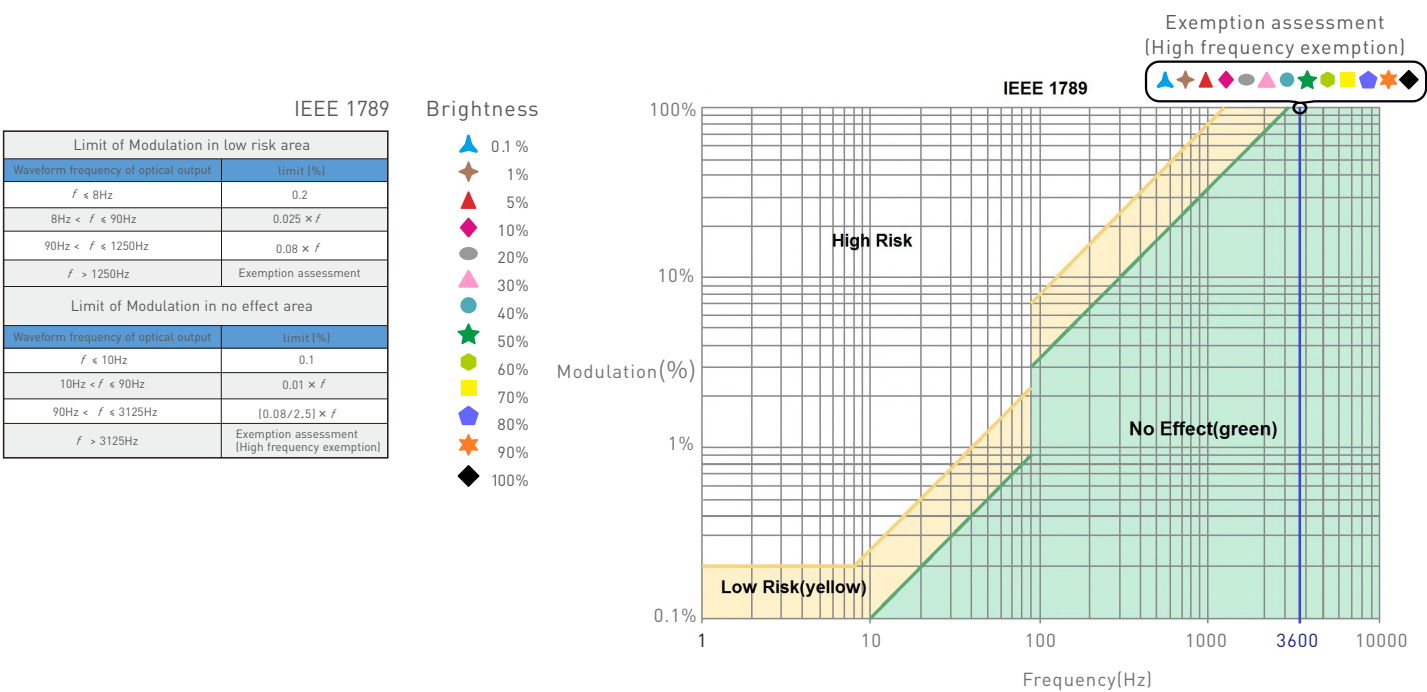

Packaging Specifications

Model	LM-240-24-G2B
Carton Dimensions	400x350x120mm(LxWxH)
Quantity	10 PCS/Layer; 2 Layers/Carton; 20 PCS/Carton
Weight	0.555 kg/PC; 12 kg±5%/Carton

Packaging Image

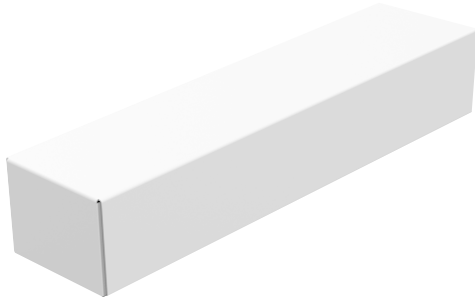

Inner Packaging Box



Carton Packaging

Transportation and Storage

1. Transportation

Products can be shipped via vehicles, boats and planes.

During transportation, products should be protected from rain and sun. Please avoid severe shock and vibration during the loading and unloading process.

2. Storage

The storage conditions should comply with the Class I Environmental Standards. The products that have been stored for more than six months are recommended to be re-inspected and can be used only after they have been qualified.

Attentions

- Products shall be installed by qualified professionals.
 - LTECH products are and not lightningproof non-waterproof (special models excepted). Please avoid the sun and rain. When installed outdoors, please ensure they are mounted in a water proof enclosure or in an area equipped with lightning protection devices.
 - Good heat dissipation will prolong the working life of products. Please ensure good ventilation.
 - Please check if the working voltage used complies with the parameter requirements of products.
 - The diameter of wire used must be able to load the light fixtures you connect and ensure the firm wiring.
 - Before you power on products, please make sure all the wiring is correct in case of incorrect connection that causes damage to light fixtures.
 - If a fault occurs, please do not attempt to fix products by yourself. If you have any question, please contact your suppliers.
- * This manual is subject to changes without further notice. Product functions depend on the goods. Please feel free to contact our official distributors if you have any question.

Warranty Agreement

- Warranty periods from the date of delivery: 5 years.
- Free repair or replacement services for quality problems are provided within warranty periods.

Warranty exclusions below:

- Beyond warranty periods.
- Any artificial damage caused by high voltage, overload, or improper operations.
- Products with severe physical damage.
- Damage caused by natural disasters and force majeure.
- Warranty labels and barcodes have been damaged.
- No any contract signed by LTECH.

1. Repair or replacement provided is the only remedy for customers. LTECH is not liable for any incidental or consequential damage unless it is within the law.
2. LTECH has the right to amend or adjust the terms of this warranty, and release in written form shall prevail.

Update Log

Version	Updated Time	Update Content	Updated by
A0	2023.12.06	Original version	Li Siyu
A1	2025.10.31	Replace the logo; update the product silk screen and company address	Shaoyun He

LED智能色温驱动器(恒压型)

- 外壳采用科思创/三星PC阻燃V0级原料
- 免螺丝压线翻盖设计, 可拆卸端盖, 按需调节壳体长度
- 通过手机APP可更改渐变时间、通电状态等参数, 实现驱动器数据交互功能
- Bluetooth 5.0 SIG Mesh通信协议, 组网能力强, 可靠稳定
- 支持iOS和安卓智能设备蓝牙直连控制
- 带软启动渐亮功能, 让人眼视觉更舒服
- 0-100%全程调光无可视频闪
- 调光范围0~100%, LED从0.0001%开始调光
- 欧盟ERP空载功耗、网络待机功耗<0.5W
- 过温、过载、短路保护, 可自动恢复
- 适合室内 I、II、III类灯具应用
- 常规使用下寿命可达10万小时
- 5年保修期 (采用红宝石电容)



T-PWM
超深度调光技术

无频闪
IEEE 1789



调光调色温

Dimmable:
1:1000000



可编程



认证图标仅代表产品正在进行一系列的认证申请, 认证资质以产品实物为准。



过温保护



过压保护



过流保护



短路保护

技术参数

型号		LM-240-24-G2B		
特征	输出类型	恒压		
	调光接口	Bluetooth 5.0 SIG Mesh		
	输出特征	隔离		
	防护等级	IP20		
输出	绝缘等级	II类 (适用于室内 I、II、III类灯具)		
	输出电压	24Vdc		
	输出电压范围	24Vdc±0.5Vdc		
	输出电流	Max. 10A		
	负载功率	Max. 240W		
	调光范围	0-100%, 调光深度: 0.0001%		
	纹波与噪声(最大)	200mVp-p		
	电压精度	±5%		
输入	PWM频率	≤22000Hz (NFC设置范围300-22000Hz)		
	直流电压范围	200-250Vdc		
	交流电压范围	220-240Vac		
	应急输出系数	EoFv=99.6%		
	额定电压	220-240Vac		
	频率范围	0/50/60Hz		
	输入电流	Max. 1.18A/230Vac		
	功率因数	PF>0.99/230Vac (满载)		
	谐波THD	THD≤5%@230Vac (满载)		
	效率(Typ.)	94%		
	浪涌电流	冷启动, 55A/(在50%Ipeak下测试twidth=1200us)/230Vac		
	抗浪涌	L-N: 2KV		
	漏电流	Max. 0.5mA		
环境	工作温度	ta: -20 ~ 45°C tc: 86°C		
	工作湿度	20 ~ 95%RH, 无冷凝		
	储存温度/湿度	-40 ~ 80°C/10-95%RH		
	温度系数	±0.03%/°C(0-50°C)		
保护	耐振动	10-500HZ, 2G 12分钟/周期, X, Y, Z轴各72分钟		
	过载保护	负载功率≥102%保护, 异常排除自动恢复		
	过温保护	根据PCB温度超标情况(≥110°C), 智能调节电流输出或关闭, 可自动恢复		
	过压保护	电压≥28V, 关闭输出, 可自动恢复		
安规和电磁规格	短路保护	输出线路短路进入打嗝模式, 可自动恢复		
	耐压	输入对输出:	3750Vac	
		绝缘阻抗	输入对输出: 100MΩ/500VDC/25°C/70%RH	
	安全规范	CCC	中国	GB19510.1, GB19510.14
		TUV	德国	EN61347-1, EN61347-2-13, EN62493
		CB	CB成员国	IEC61347-1, IEC61347-2-13
		CE	欧盟	EN61347-1, EN61347-2-13, EN62384
		KC	韩国	KC61347-1, KC61347-2-13
		EAC	俄罗斯	IEC61347-1, IEC61347-2-13
		RCM	澳洲	AS 61347-1, AS 61347-2-13
		ENEC	欧洲	EN61347-1, EN61347-2-13, EN62384
		UKCA	英国	BS EN 61347-1, BS EN 61347-2-13, BS EN 62493
		BIS	印度	IS 15885 (PART 2/SEC 13)
	电磁兼容发射	CCC	中国	GB/T17743, GB17625.1
		CE	欧盟	EN55015, EN61000-3-2, EN61000-3-3, EN61547
		KC	韩国	KSC 9815, KSC 9547
		EAC	俄罗斯	IEC62493, IEC61547, EH55015
RCM		澳洲	EN55015, EN61000-3-2, EN61000-3-3, EN61547	
UKCA		英国	BS EN IEC 55015, BS EN IEC 61000-3-2, BS EN 61000-3-3, BS EN 61547	
电磁兼容抗扰度	EN61000-4-2,3,4,5,6,8,11, EN61547			
ErP	功耗	网络待机功耗	<0.5W (通过指令开关后)	
		空载功耗	<0.5W (不接灯具时)	
	频闪/频闪效应	IEEE 1789	满足无影响/高频豁免考核级别	
		CIE SVM	Pst LM≤1.0, SVM≤0.4	
DF	相位因素	DF≥0.9		
其他	产品重量	555g±10g		
	产品尺寸	380×49.5×30mm(LxWxH)		

本款驱动器适合连接电阻限流的LED灯具(如: LED灯条)。如果连接内置恒流IC限流的灯具, 会产生几十倍的瞬间浪涌电流, 导致驱动器会执行过载保护(打嗝频闪)。下单时这类内置恒流IC限流的灯具需要注明(如: Mr16灯杯、地理灯、洗墙灯、恒流硬灯条等), 以便烧写特殊程序。

尺寸图

单位: mm

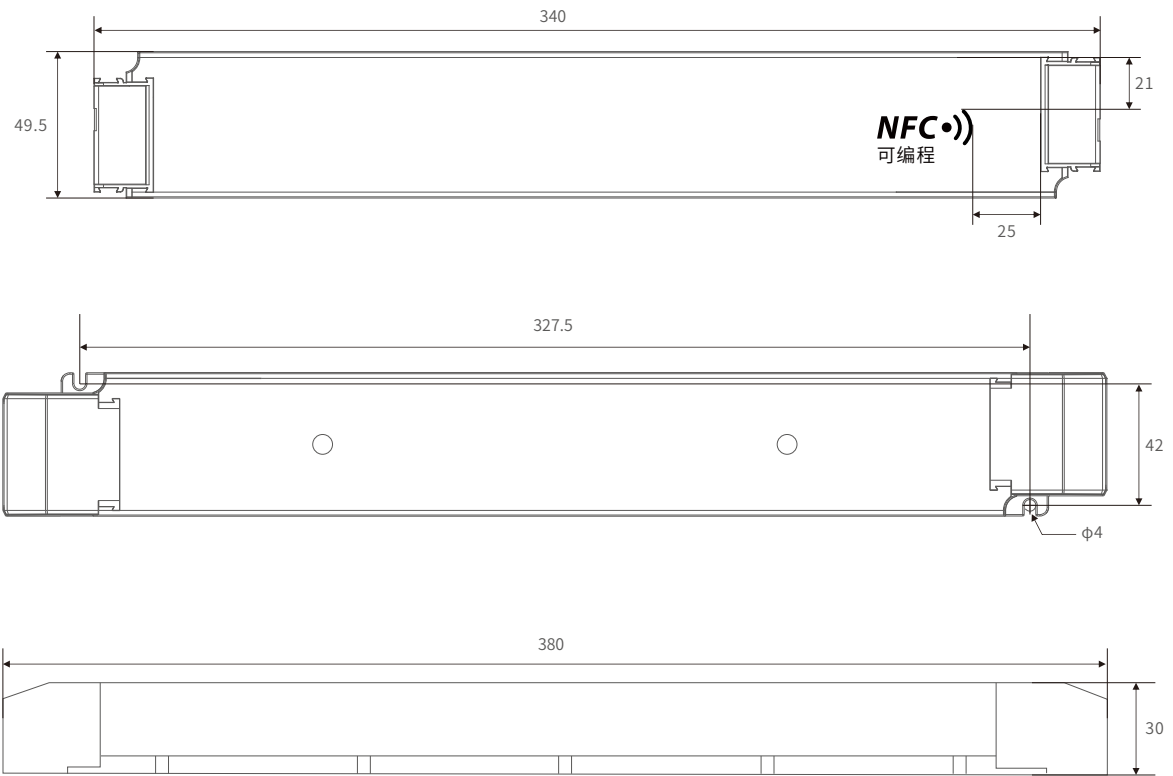

连接应用图

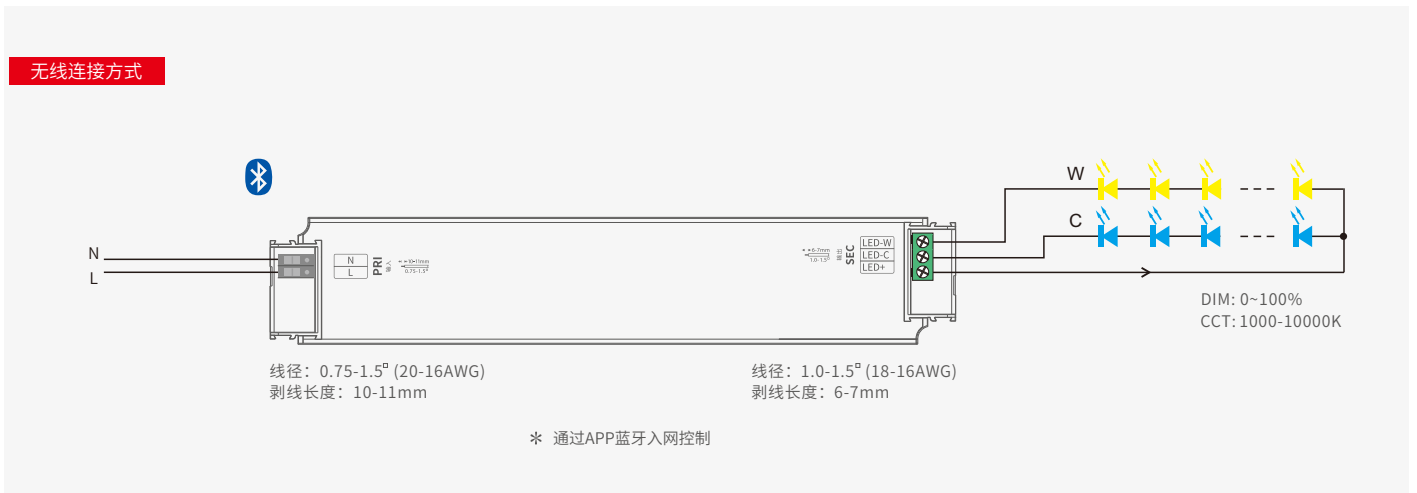

保护盖应用图

压线安装

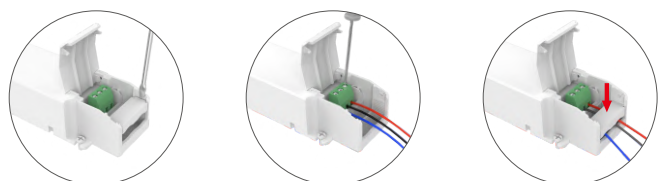

打开保护盖, 用螺丝批撬起压线板侧边即可拆下, 按照接线图接线后向下按压压线板固定住线, 合上保护盖即可。

保护盖拆卸



在外壳底部往下按压并左右掰动, 即可将保护盖拆下。

安装注意事项

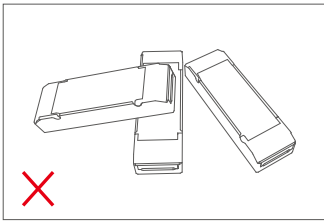

请勿将产品堆叠摆放，产品与产品间隔距离应 $\geq 15\text{cm}$ ，避免影响产品散热和使用寿命。

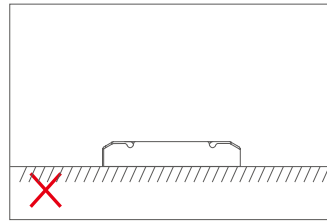
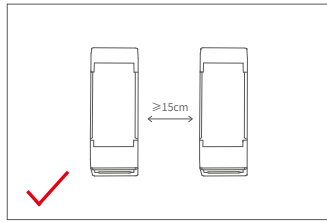

请勿将产品放置地面，与地面间隔距离应 $\geq 100\text{cm}$ ，以免信号干扰影响使用。

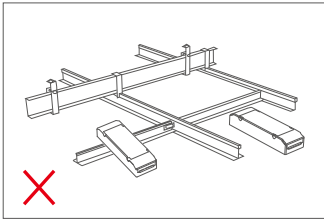
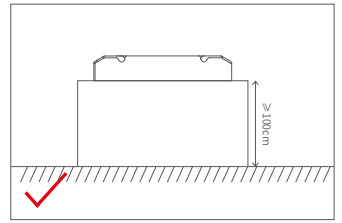

请勿将产品大面积接触金属物体(如：龙骨架)，间隔距离应 $\geq 15\text{cm}$ ，以免信号干扰影响使用。

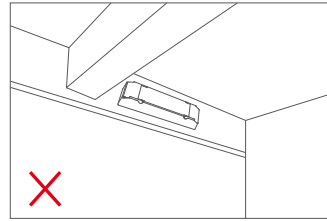
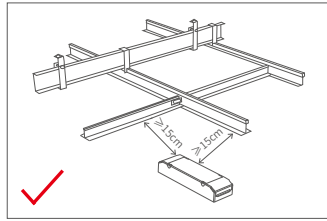

请勿将产品安装在横梁、墙角等位置，间隔距离应 $\geq 15\text{cm}$ ，以免信号干扰影响使用。

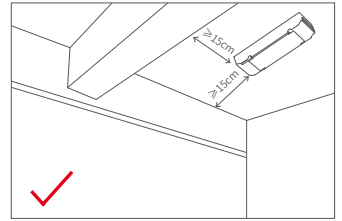

注：安装需符合产品的环境工作温度，切勿安装到灯具内部，以免超出产品环境工作温度影响产品寿命。

搭配 NFC Lighting APP 使用

通过手机扫描下方二维码，按提示完成APP安装。(因性能需求，要求手机型号苹果：iPhone 8及以上、且操作系统iOS13及以上； 安卓：具备NFC功能机型)



* 设置驱动器参数时，必须在驱动器断电情况下进行操作。

读/写智能电源

使用手机，通过NFC读取驱动器信息，根据需求设置参数后，可直接写入驱动器。

1. 读取驱动器

在APP“首页”点击【读/写智能电源】，将手机感应区域靠近驱动器NFC感应区，读取驱动器参数。

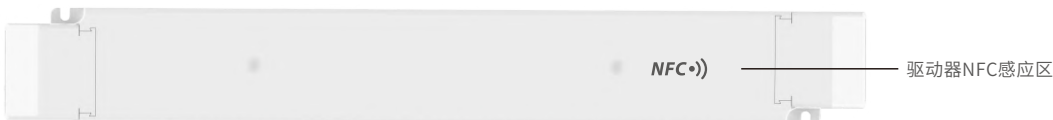

2. 编辑参数

点击【参数管理】可编辑开/关灯渐变时间、通电渐变时间、色温范围等更多高级参数。

3. 写入驱动器

参数设置完成后，点击右上角【写入】，将手机感应区域靠近驱动器NFC感应区，即可写入驱动器成功修改参数。



蓝牙系统图

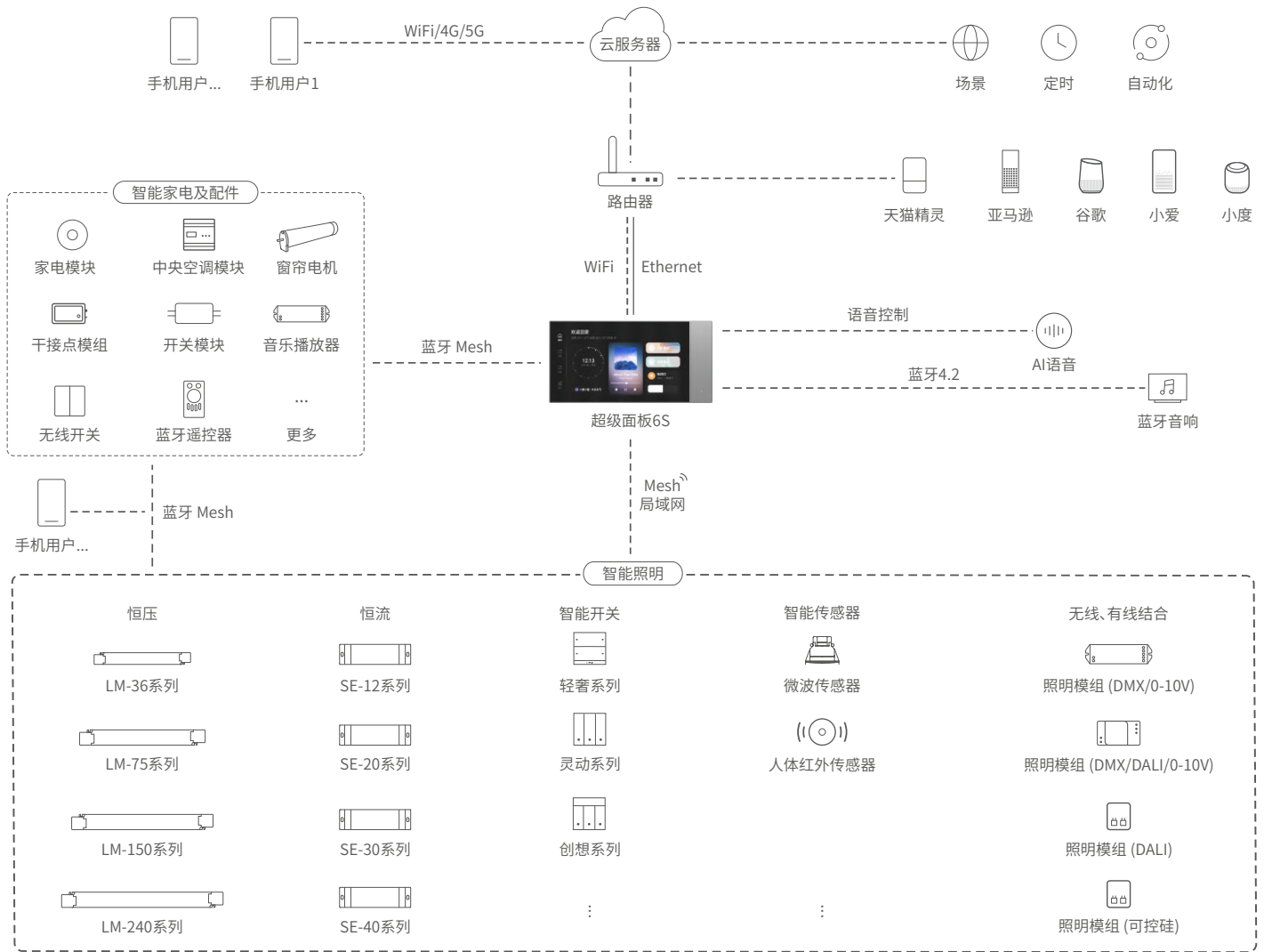

推荐应用控制方式

1、快速实现本地调光。

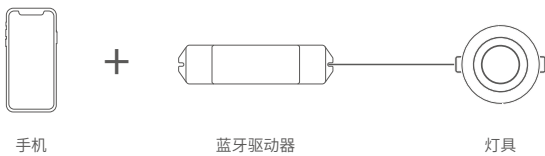

2、通过APP设置遥控关联驱动后，可实现APP与遥控两种控制方式控制驱动。

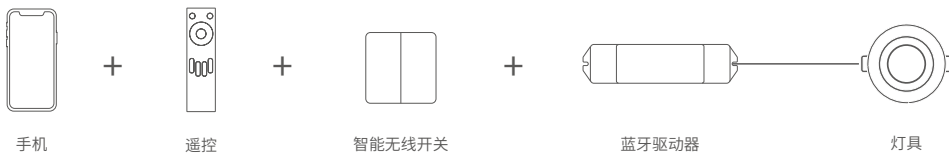

3、通过APP设置面板关联驱动，可实现APP与面板同时控制。并能够通过面板联网，可实现APP远程控制驱动，云场景，自动化联动功能。



4、.....智能控制，更多应用搭配等您来设置。

搭配蓝牙 L-Home APP 使用

1. 账号注册

APP兼容iOS和Android系统，通过手机扫描下方二维码，按提示完成APP安装，安装后即可进行登录/注册操作。



2. 配对操作

新用户创建家庭后，点击右上角“+”进入添加设备列表，先将驱动器按照提示添加完成后，在添加设备列表选择“智能照明-色温灯”后，按照界面提示，先将设备接通电源，确保设备处于未入网状态。然后点击“蓝牙搜索”后，按照提示完成添加设备。



3. 控制界面设置

配对完成后，进入控制界面，可以通过调节色温，亮度达到想要的灯光效果。点击主题，进入主题界面，可一键切换多种主题灯光效果。点击模式，具有可编辑的高级模式。自定义动态模式，让您的生活更加丰富多彩。

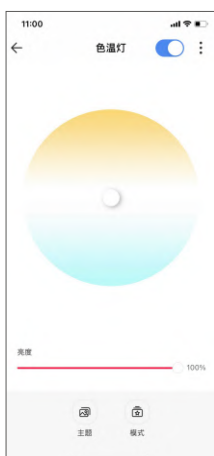

4. 灯具群组

同类型的灯具可以组成群组，用户可以对群组进行调色、调光等操作，操作更加便利。在添加设备列表中选择“群组—色温灯组”，按照界面提示编辑灯组名称后，点击“下一步”，勾选您要组成群组的设备，保存即可。



5. 高级功能

本产品可以通过与具有网关功能的设备联动，如超级面板6S。可实现云场景、自动化等高级功能。



重置设备 (恢复出厂设置)

确保驱动已接灯具且处于常亮状态下，使用开关让驱动连续断通电6次（每次断电时间15秒，通电2秒），第六次通电2秒后，灯具闪烁5次，即表示驱动已恢复到出厂设置状态。

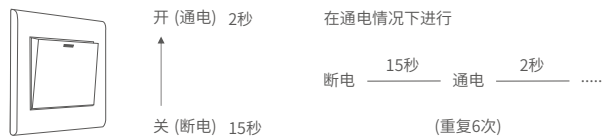

关系图表

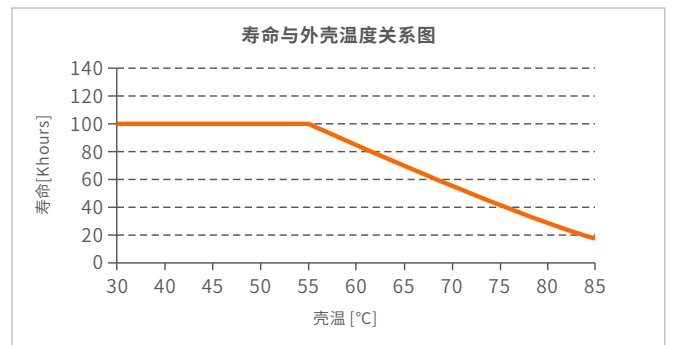
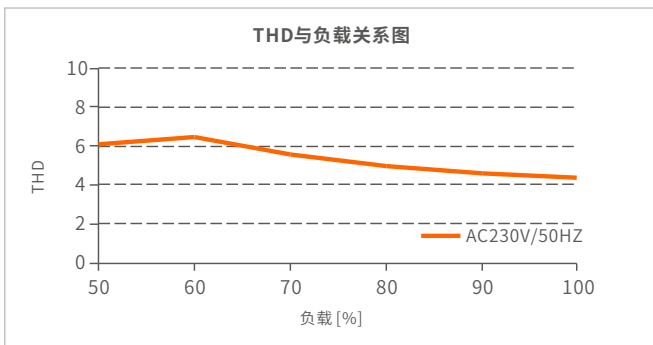
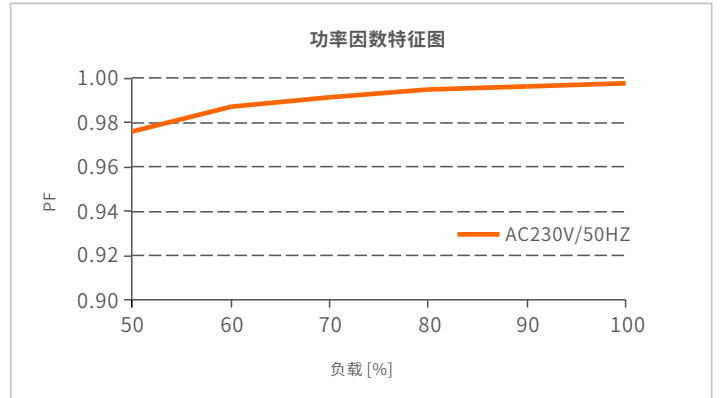
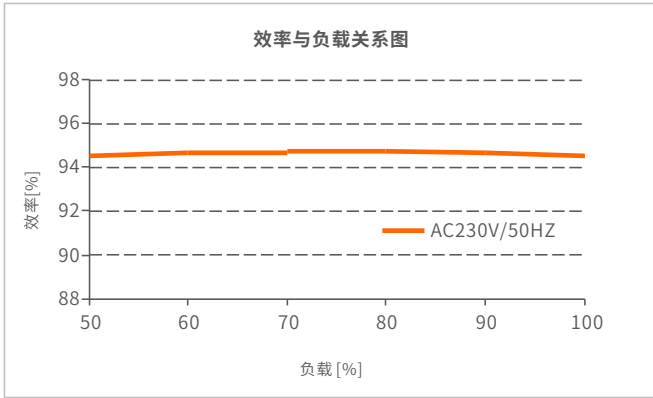

频闪测试表

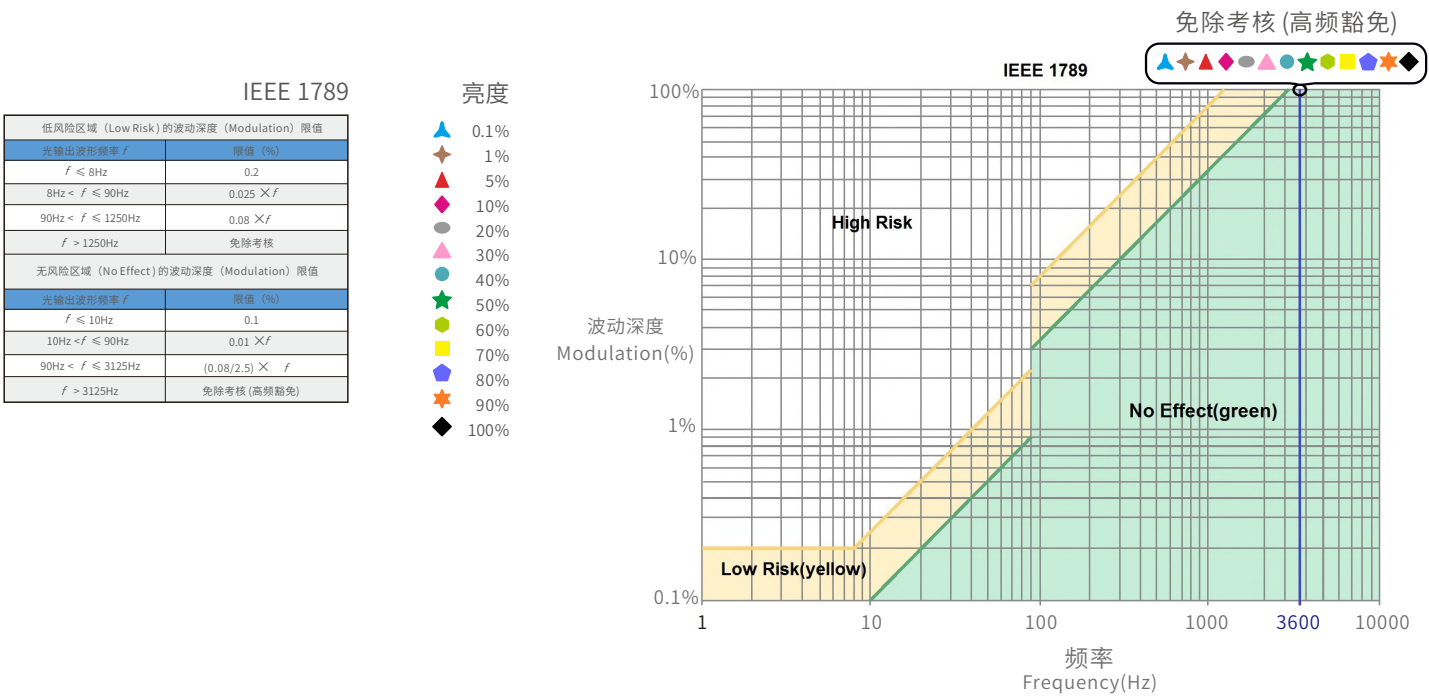

包装规格

型号	LM-240-24-G2B
包装箱尺寸	400×350×120mm(L×W×H)
数量	10PCS/层; 2层/箱; 20PCS/箱
重量	0.555kg/PC; 12kg±5%/箱

包装样式图

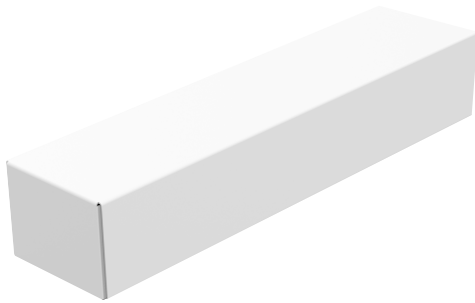

内包装盒



整箱包装

运输和贮存

1. 运输

产品适用车、船、飞机交通运输工具运输。

在运输中，应使用遮篷进行防雨和防晒，并保持文明装卸，不应有剧烈振动、撞击等。

2. 贮存

贮存符合I类环境的规定。贮存期限超过6个月的产品建议重新检验，合格后方可使用。

注意事项

- 请由具有专业资格的人员进行调试安装；
- 雷特产品（专有型号除外）不能防水防雷，需避免日晒雨淋，如安装在户外，请用防水箱和防雷装置；
- 良好的散热条件会延长产品的使用寿命，请把产品安装在通风良好的环境；
- 请检查使用的工作电压是否符合产品的参数要求；
- 使用的电线直径大小必须能够负载连接的LED灯具，并确保接线牢固；
- 通电调试前，应确保所有接线正确，以避免因接线错误而导致灯具损坏；
- 如果发生故障，请勿私自维修；如有疑问，请联系供应商。

* 本说明书的内容如有变更，恕不另行通知。若内容与您使用的功能有所不同，则以实物为准。如有疑问，欢迎向我司授权的经销商咨询。

保修条例

- 自出厂之日起保修服务期为5年。
- 在保修服务期内出现产品质量问题雷特将给予免费修理或更换服务。

非保修条例:

属下列情况不在免费保修或更换服务范围之内:

- 已经超出保修服务期;
- 过高电压、超负载、操作不当等人为造成的损坏;
- 产品外形严重损坏或变形;
- 自然灾害以及人力不可抗拒原因造成的损坏;
- 产品保修标签和产品唯一条形码损坏;
- 无雷特签订的合同或发票凭证。

1. 修理或更换是雷特对客户唯一补救措施。雷特不承担任何附带引起的损害赔偿责任, 除非在适用法律范围之内。
2. 雷特享有修正或调整本保修条款的权利, 并以书面形式发布为准。

更新日志

版本	更改日期	更改内容	更改人
A0	2023.03.06	正稿	刘伟丽
A1	2025.10.31	更换logo; 更新镭雕和公司地址	何少云