

Intelligent Tunable White LED Driver (Constant Voltage)

- Housing made of Sichuang/Samsung PC flame-retardant V0 grade raw material, screwless end cap for easy assembly and disassembly, and shell length adjustable as required.
- Matter-certified device that communicates over an IPv6 Thread network. It must be used with a Matter hub that features Thread Border Router functionality (e.g., Apple HomePod mini or Google Nest Hub).
- Supports control via mainstream Matter smart home platforms, including Apple Home, SmartThings, Google Home, etc., and supports voice control.
- Easy commissioning and pairing by scanning the QR code.
- Supports standard Matter OTA upgrade.
- Supports NFC programming to modify parameters such as dimming fade time, power-on fade time, brightness range, etc.
- Built-in soft start and gradual brightening function for a more comfortable visual experience.
- Dimming range: 0-100%, LED dimming starts from 0.0001%.
- Compliant with EU ERP energy efficiency directive; no-load power consumption < 0.5W, network standby power consumption < 0.5W.
- Innovative thermal management technology to intelligently protect the service life of the led driver.
- Over-temperature, over-voltage, overload and short-circuit protection with automatic recovery.
- Suitable for indoor Class I, II and III luminaires.
- Service life up to 100,000 hours under normal operation.
- 5-year warranty (adopting Rubycon capacitors).



T-PWM Dimming Technology

Flicker-Free IEEE 1789

Dimmable: 1:1000000

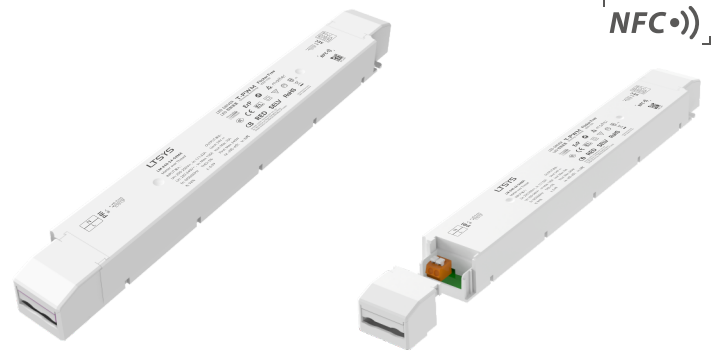

Technical Specs

Model	LM-240-24-G2MA			
Features	Output Type	Constant voltage		
	Dimming Interface	Matter over Thread, Matter 1.4		
	Output Feature	Isolation		
	Protection Grade	IP20		
	Insulation Grade	Class II (Suitable for class I/ II /III light fixtures)		
OUTPUT	Output Voltage	24V $\overline{\text{m}}$		
	Output Voltage Range	24V \pm 0.5V $\overline{\text{m}}$		
	Output Current	Max. 10A		
	Output Power	Max. 240W		
	Output Power Range	0~240W		
	Dimming Range	0-100%, down to 0.0001%(Set More levels can be set via mobile APP NFC; Default: 0.01%)		
	Overload Power Limitation	\geq 102%		
	Ripple & Noise	Switch ripple \leq 200mV, noise \leq 500mV		
	PWM Frequency	300-22000Hz		
INPUT	Input AC Voltage	220-240V~		
	Input DC Voltage	220-250V $\overline{\text{m}}$		
	EoFv	EoFv=99.6%		
	Frequency	0/50/60Hz		
	Input Current	Max. 1.18A/230V~		
	Power Factor	PF>0.99/230V~ (at full load)		
	THD	THD<10%@ 230V~(at full load)		
	Efficiency (Typ.)	94%		
	Inrush Current	Cold start 55A(Test twidth=1200us tested under 50% Ipeak)/230V~		
	Anti Surge	L-N: 2KV		
	Leakage Current	Max. 0.5mA		
ENVIRONMENT	Working Temperature	ta: -20 ~ 50°C tc: 80°C		
	Working Humidity	20 ~ 95%RH, non-condensing		
	Storage Temperature/Humidity	-40 ~ 80°C, 10~95%RH		
	Temperature Coefficient	\pm 0.03%/°C(-20°C-50°C)		
	Vibration	10~500Hz, 2G 12 mins/cycle, 72 min for X, Y and Z axes respectively		
PROTECTION	Overheat Protection	Intelligently adjust or turn off the output current if the PCB temperature \geq 110°C, and recover automatically		
	Overload Protection	Automatically protect the device when the load exceeds 102% of the rated power. Automatically recover once load is reduced		
	Short Circuit Protection	Enter hiccup mode if short circuit occurs, and recover automatically		
	Overvoltage Protection	Shut down the output when no-load voltage \geq 28V, and recover automatically		
SAFETY & EMC	Withstand Voltage	I/P-O/P:3750V~		
	Insulation Resistance	I/P-O/P: 100M Ω /500VDC/25°C/70%RH		
	Safety Standards	CCC	China	GB19510.1, GB19510.14, GB19510.213
		CB	CB Member States	IEC61347-1, IEC61347-2-13
		CE	European Union	EN61347-1, EN61347-2-13, EN62384
	EMC Emission	CCC	China	GB/T17743, GB17625.1
		CE	European Union	EN55015, EN61000-3-2, EN61000-3-3, EN61547
	EMC Immunity	EN61000-4-2,3,4,5,6,8,11,EN61547		
	ErP	Power Consumption	Networked standby	< 0.5W (After shutdown by command)
No-load power consumption			< 0.5W(When the lamp is not connected)	
Flicker/Stroboscopic Effect		IEEE1789	Meet IEEE 1789 standard/High frequency exemption level	
		CIE SVM	PstLM \leq 1.0, SVM \leq 0.4	
DF	Phase factor	DF \geq 0.9		
OTHERS	Weight(N.W.)	555g \pm 10g		
	Dimensions	380 \times 49.5 \times 30mm(L \times W \times H)		

This driver is suitable for connecting LED lighting fixtures with resistor current limiting (such as LED light strips). If it is connected to a fixture with built-in constant current IC for current limiting, an instantaneous inrush current dozens of times higher will be generated, causing the driver to activate overload protection (hiccup and strobing). When placing an order, such fixtures with built-in constant current IC for current limiting (e.g., MR16 bulbs, underground lights, wall washers, constant current hard light strips, etc.) need to be specified to facilitate the burning of a special program.

Product Size

Unit: mm

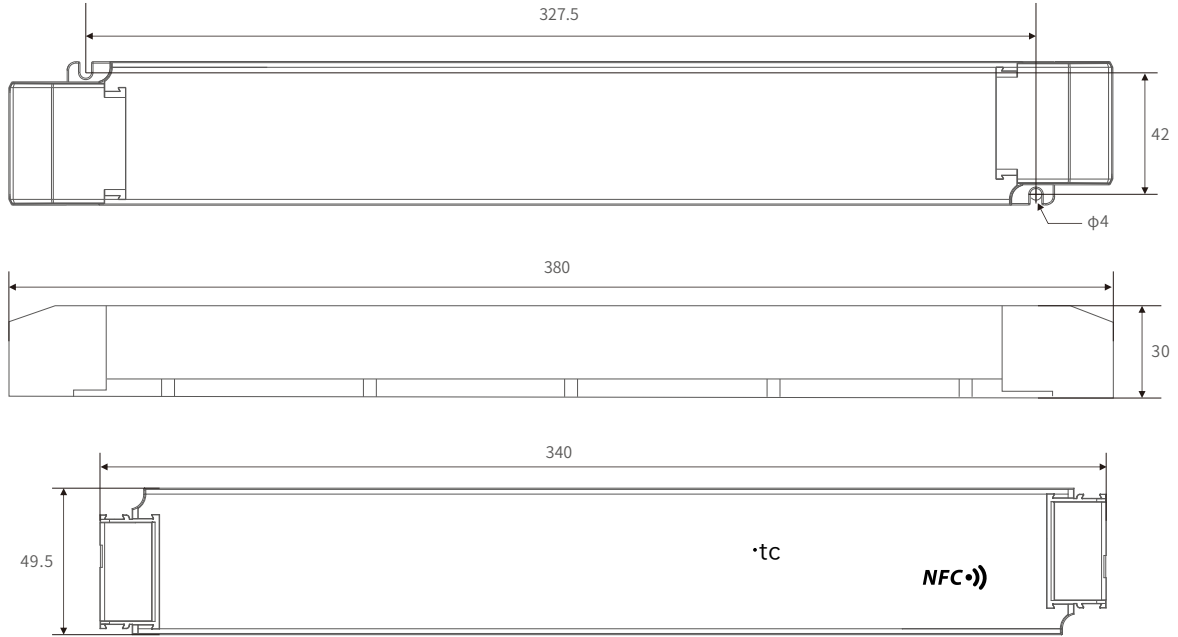

Wiring Diagram

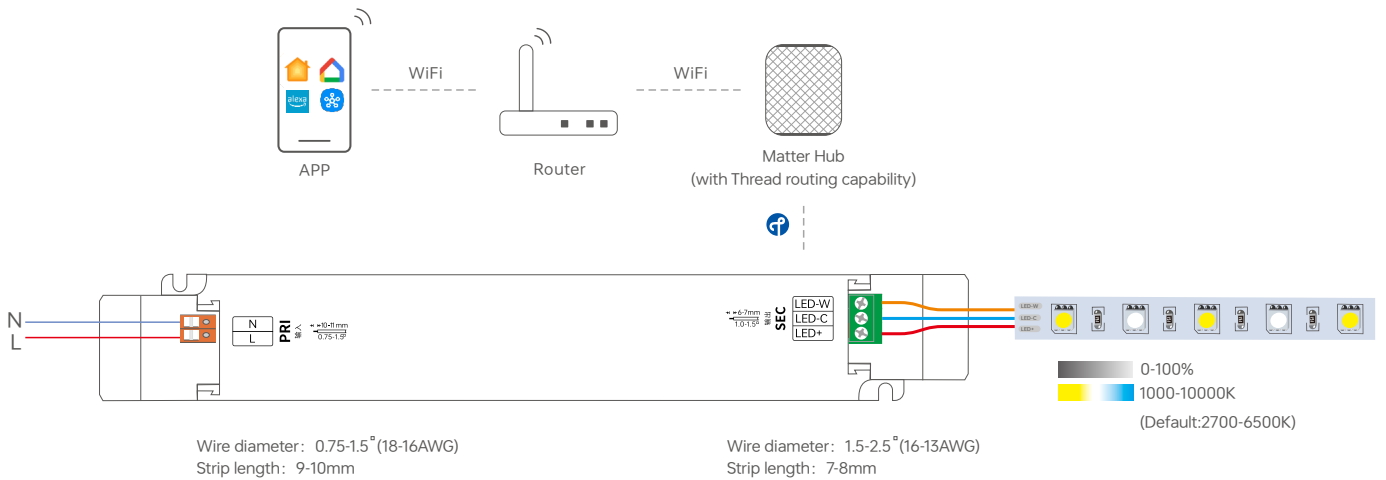

*Network access and control via mobile APP

Protective Housing Application Diagram

Tension plate

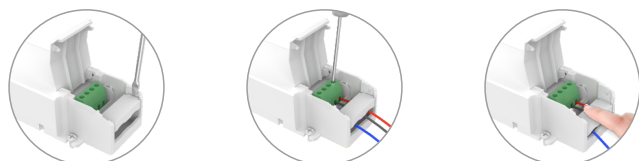

1. Pry up the protecting housing at the side plate position with a tool.
2. Connect to electrical wires with a screwdriver as shown in the wiring diagram.
3. Press down the tension plate to fix the the electrical wires, then close the protective housing.

Remove the protective housing

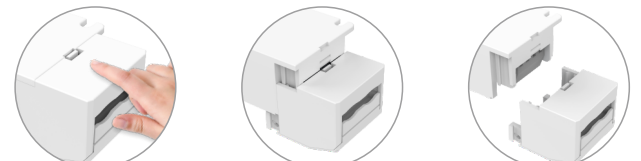

Pull the housing left and right from the bottom to remove it.

Installation Precautions

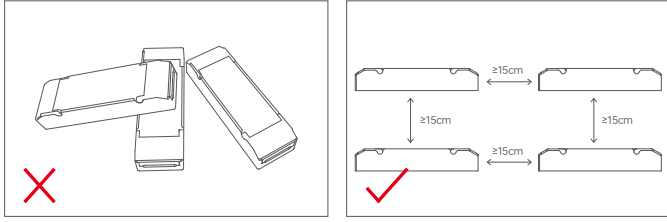

Please do not stack the products. The distance between two products should be $\geq 15\text{cm}$ so as not to affect heat dissipation and the lifespan of the products.

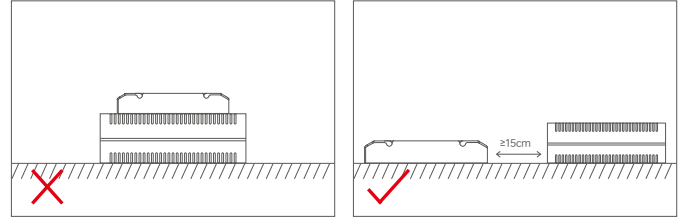

Please do not place the products on the floor. The distance between the product and the floor should be $\geq 100\text{cm}$ so as to avoid signal interference.

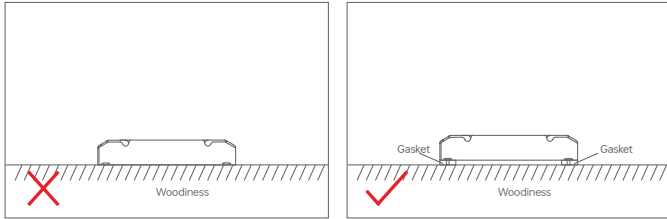

Do not fix the product tightly against the wooden board with screws. Please add a washer $\geq 7\text{mm}$ thick under the mounting screws to leave a gap for effective heat dissipation, so as to avoid affecting the heat dissipation and service life of the product.

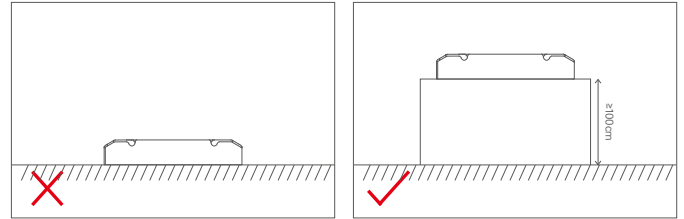

Please do not place the products on the floor. The distance between the product and the floor should be $\geq 100\text{cm}$ so as to avoid signal interference.

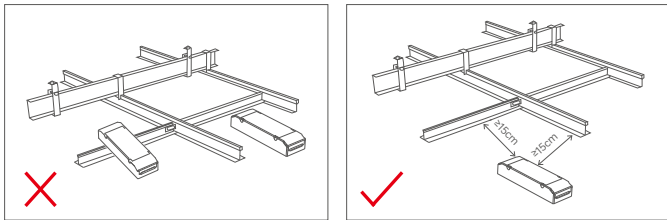

Do not allow the product to come into large-area contact with metal objects (e.g. keel frames). The separation distance shall be $\geq 15\text{cm}$ to avoid signal interference affecting operation.

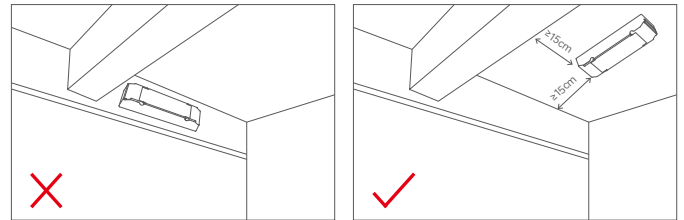

Please do not install the products on beams or near the corners. The distance between the product and the beam or the corner should be $\geq 15\text{cm}$ so as to avoid signal interference.

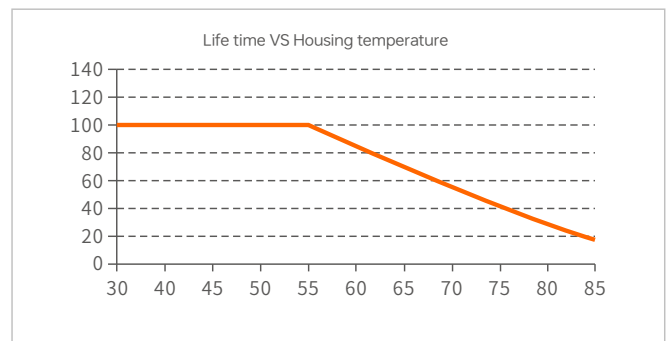
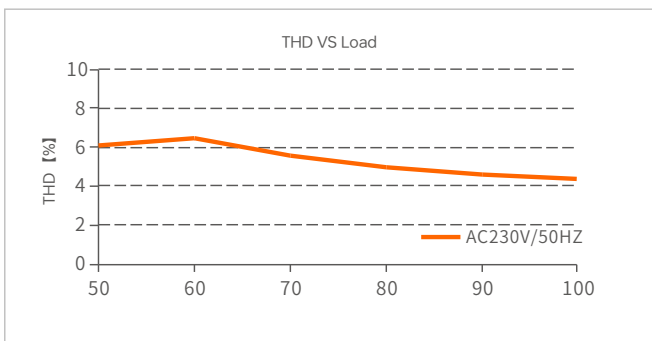
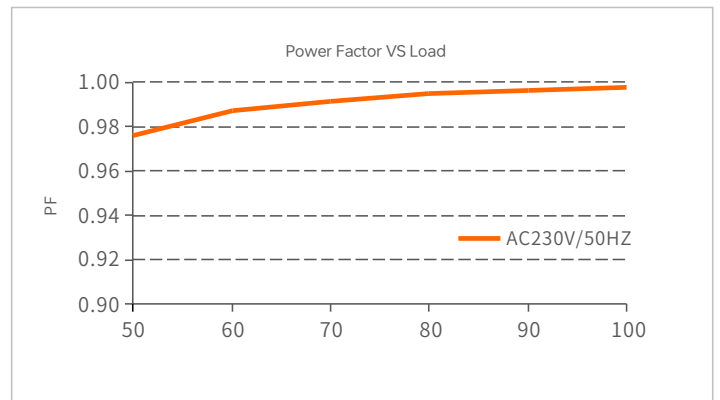
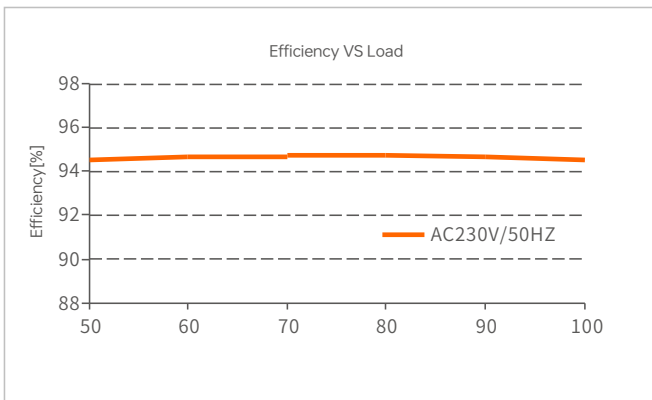

Surge Current & Corresponding Miniature Circuit Breaker (MCB) Load Capacity Table

MCB Model	B10	B13	B16	B20	B25	C10	C13	C16	C20	C25	D10	D13	D16	D20	D25
Maximum Load Capacity	2	3	4	6	9	5	7	9	12	16	7	9	13	18	24

Remarks:

1. Test Conditions: Cold start 55A(Test twidth=1200us tested under 50% Ipeak)/230V~.
2. The number of supported drivers may vary depending on the brand and model of the MCB.
- 3.It is recommended not to exceed the specified load capacity during on-site installation. The actual load should be determined based on field conditions.
- 4.If the ambient temperature exceeds 30°C or multiple MCBs are installed side by side, the number of installed drivers must be reduced and recalculated accordingly.
- 5.Electricians typically use Type B MCBs for residential lighting and Type C MCBs for commercial lighting applications.
- 6.Different testing equipment may yield variations in measured current peaks and pulse widths. Always use professional-grade instruments for accurate testing.

Flicker Test Table

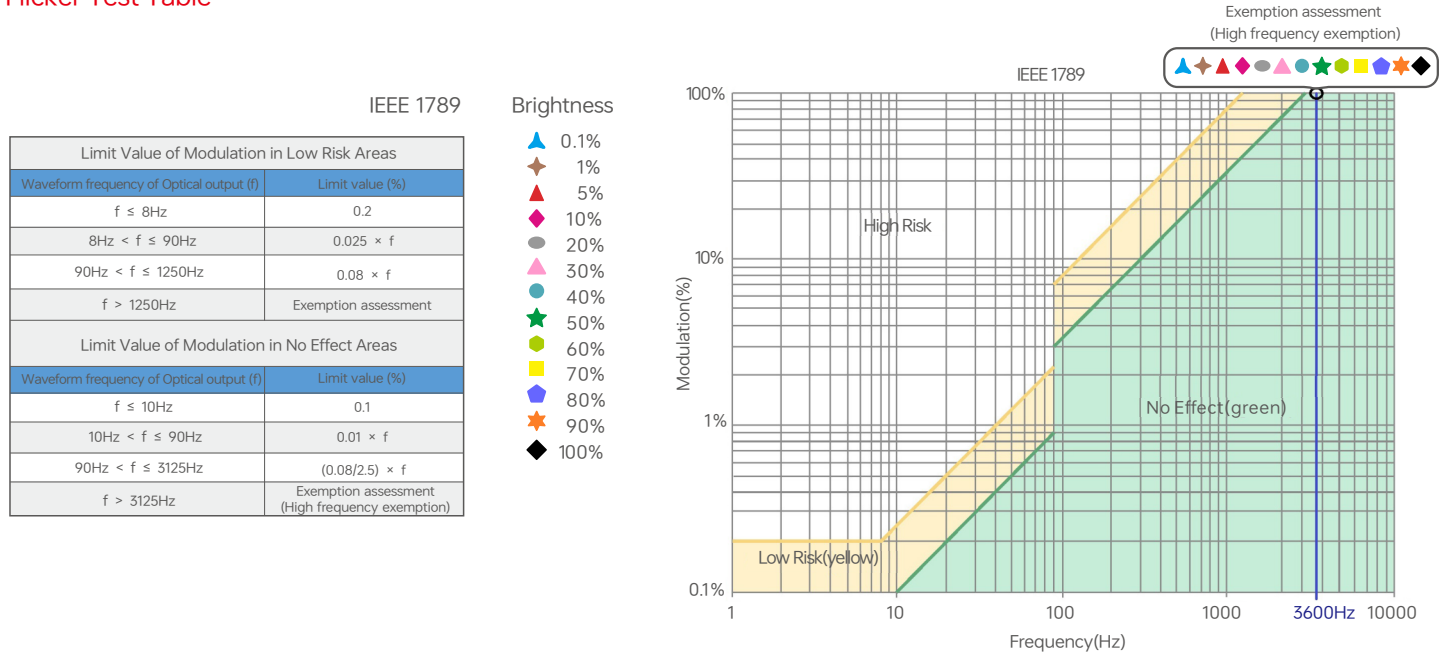

Add to Matter Platform Instructions

1. This device supports control via major smart home platforms, including Apple Home, Amazon Alexa, Google Home, SmartThings, and others.
2. To connect Matter over Thread devices, you need a Matter hub supporting Thread border router functionality from major platforms. Refer to the image below for compatible models.

Apple Home	Google Home	Amazon Alexa	SmartThings
Apple HomePod (second-gen)	Google Nest Hub (2nd Gen)	Amazon Echo (4th-gen)	Aeotec SmartThings Smart Home Hub
Apple HomePod Mini	Google Nest Hub Max	Amazon Echo Hub	Samsung SmartThings Station
Apple TV 4K (2nd gen)	Google Nest Wifi Pro	Amazon Echo Show 8 (3rd-gen)	Samsung SmartThings Hub Dongle
Apple TV 4K (3rd gen,128 GB)	Google TV Streamer (4K)	Amazon Eero 6, Pro 6, 6 Plus, Max 7 etc.	Samsung SmartThings Hub v3

3. This guide uses Apple Home as an example. First, prepare an iPhone (iOS 16.2 or later) or iPad (iPadOS 16.2 or later) with the latest firmware, along with an Apple HomePod mini also running the latest firmware. Then connect your iPhone or iPad to your home Wi-Fi network, launch the Apple Home app, and follow Apple's instructions to set up the HomePod mini.

*For iPhone models 16 and above, no Matter hub is required; devices can be added directly.

Adding Steps (Using Apple Home as an Example)

1.Add Accessory

Open the Apple Home app, tap Add or Scan Accessory, and add the device to the Home app by scanning the QR code label on the device, as shown below.

*Alternatively, add via NFC: Open the Home app, bring it close to the device’s NFC sensing area for recognition and network connection.

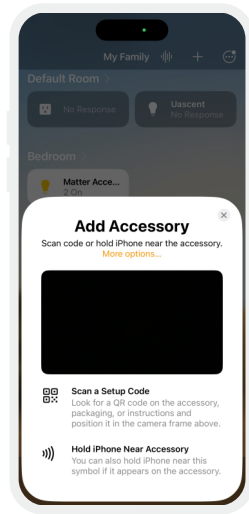
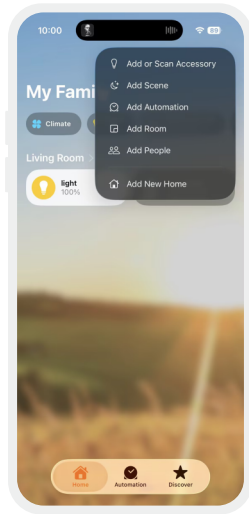

2.Control the Device

After the device has been successfully added, tap the device icon to turn it ON/OFF; tap the device card to enter the brightness and color temperature control interface.

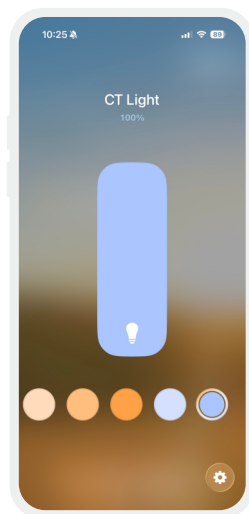
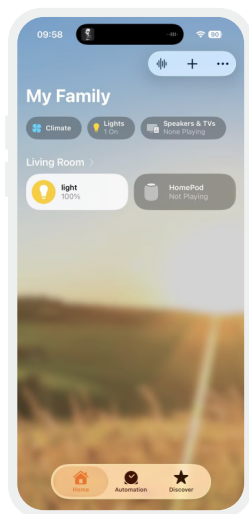

3. Advanced Functions

Supports creating groups, scenes, automation, remote control and timer control. The device can also be controlled via Siri voice commands.

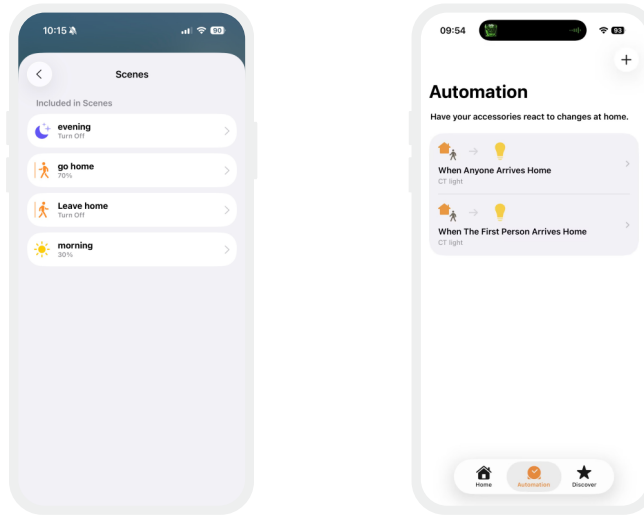

4. Multi-Ecosystem Network Configuration

If the product needs to be added to two or more ecosystems, you may go to the device settings page, tap Enable Pairing Mode, obtain the pairing code, and add it to third-party platforms.

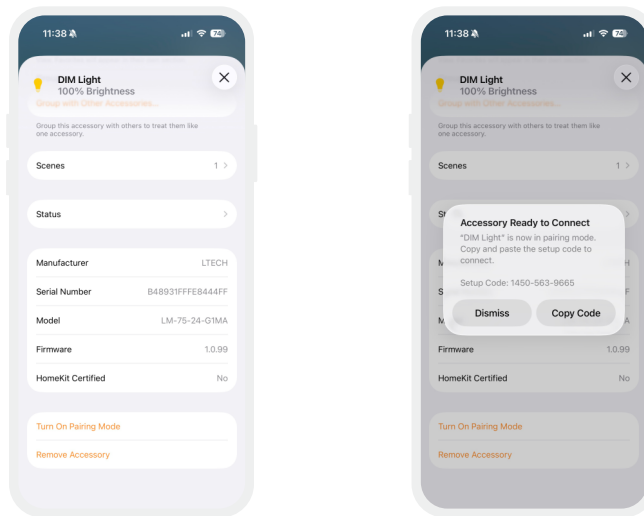

Reset to the defaults

Ensure the device is connected to the light and the light stays on steadily. Turn the power off and on 6 times in a row using the switch: (Turn off for 15 seconds, Turn on for 2 seconds) After the 6th time you turn it on (leave it on for 2 seconds), the light will flash 5 times. This means the device has been successfully restored to factory settings.

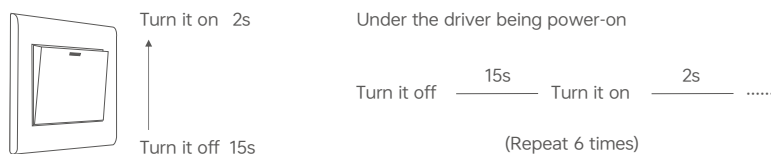

Use the NFC Lighting APP

Scan the QR code below with your mobile phone and follow the prompts to complete the APP installation (According to performance requirements, you need to use a NFC-capable Android phone, or an iPhone 8 and later that are compatible with iOS 13 or higher).



* Before you begin setting the parameters of the driver, please make sure the driver is powered off .

Read/Write the LED driver

Use your NFC-capable phone to read LED driver data, then edit the parameters and they can be directly written to the driver.

1.Read the LED driver

On the APP home page, click [Read/Write LED driver] , then keep the programmer's sensing area close to the NFC sensing area of the driver to read the driver parameters.

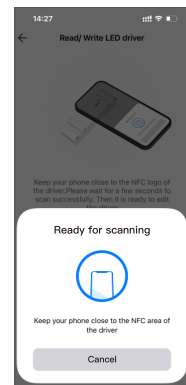
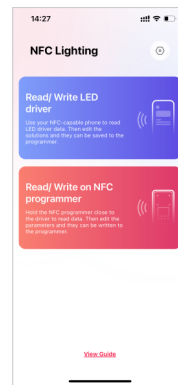
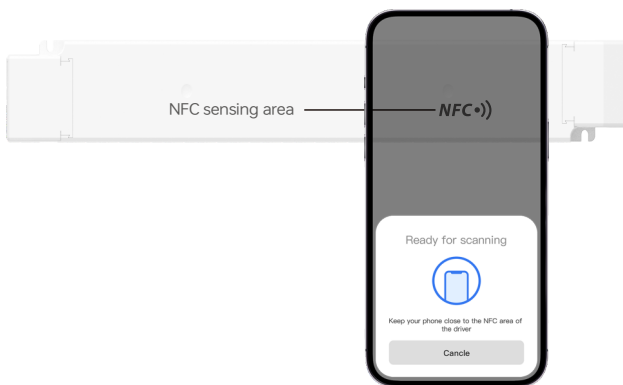

2.Edit the parameters

Click [Parameter settings] to edit more advanced parameters such as dimming fade time, power-on fade time, dimming depth, brightness range, CT range, power-on state.

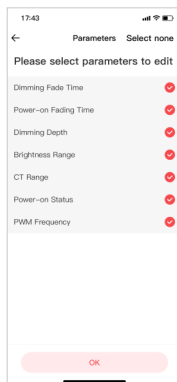
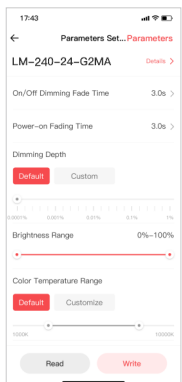

3.Write to the driver

After completing the parameter settings, click [Write] in the upper right corner, and keep the programmer's sensing area close to the NFC sensing area of the driver, so the parameters can be written to the driver.

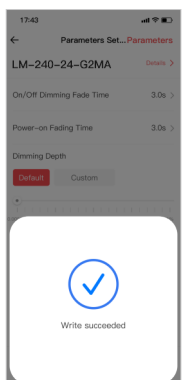

Packaging specification

Model	LM-240-24-G2MA
Packaging box size	400×350×120mm(L×W×H)
Quantity	10 PCS per layer, 3 layers per box, 30 PCS per box
Weight	0.43kg per PC, 9.4kg±5% per box

Packaging Style Drawing



Inner packaging box



Full box packaging

FAQ

This product is designed in compliance with the Matter protocol standard. As the protocol is still in the early stage of industry development and limited by the current version, some functions, performance and network connection stability may be subject to further optimization. Product performance is subject to the current version of the Matter protocol. Our company will continuously upgrade and optimize product functions and performance in line with official updates. Please kindly note.

1. What should I do if the large number of Matter devices managed by the Matter hub gateway causes unstable connections and control?

1.1 It is recommended that each hub gateway add no more than 40 Matter devices.

1.2 It is recommended that the hub gateway remain powered on at all times; otherwise, the device reconnection time will be long.

1.3 Routers of different brands and performances have a certain impact on the number of devices managed by the Matter hub. It is recommended to choose a high-performance router.

2. What should I do if packet loss occurs during group control switching or dimming, and the app status flips back and forth?

It is recommended to keep the number of devices in a group within 10 units.

3. What should I do if the device goes offline and cannot recover after a long period of inactivity?

It is recommended to power the device off and on again to reconnect.

4. What should I do if adding the device still fails after restoring it to factory settings?

Please try powering the device off and on again before adding it.

5. Common reasons for failed device addition caused by router issues.

5.1 The router must have the IPv6 option enabled.

5.2 The router must have the "Brute-force network attack prevention" option disabled.

5.3 Do not connect to the guest Wi-Fi; connect to the main Wi-Fi network instead.

Transportation and Storage

1. Transportation

Products can be shipped via vehicles, boats and planes.

During transportation, products should be protected from rain and sun. Please avoid severe shock and vibration during the loading and unloading process.

2. Storage

The storage conditions should comply with the Class I Environmental Standards. The products that have been stored for more than six months are recommended to be re-inspected and can be used only after they have been qualified.

Attentions

- Product installation and commissioning should be done by a qualified professional.
- LTECH products are and not lightningproof non-waterproof (special models excepted). Please avoid the sun and rain. When installed outdoors, please ensure they are mounted in a water proof enclosure or in an area equipped with lightning protection devices.
- Good heat dissipation will prolong the working life of products. Please ensure good ventilation.
- Please check if the working voltage used complies with the parameter requirements of products.
- The diameter of wire used must be able to load the light fixtures you connect and ensure the firm wiring.
- Before you power on products, please make sure all the wiring is correct in case of incorrect connection that causes damage to light fixtures.
- If a fault occurs, please do not attempt to fix products by yourself. If you have any question, please contact your suppliers.
- * This manual is subject to changes without further notice. Product functions depend on the goods. Please feel free to contact our official distributors if you have any question.

Warranty Agreement

- Warranty periods from the date of delivery: 5 years.
 - Free repair or replacement services for quality problems are provided within warranty periods.
- Warranty exclusions below:
- Beyond warranty periods.
 - Any artificial damage caused by high voltage, overload, or improper operations.
 - Products with severe physical damage.
 - Damage caused by natural disasters and force majeure.
 - Warranty labels and barcodes have been damaged.
 - No any contract signed by LTECH.
1. Repair or replacement provided is the only remedy for customers. LTECH is not liable for any incidental or consequential damage unless it is within the law.
 2. LTECH has the right to amend or adjust the terms of this warranty, and release in written form shall prevail.